



*Atop Technologies, Inc.*

---

***SW5501 – SW5502***  
***Wireless Serial Server***

**User Manual**

V1.4

April 20<sup>th</sup>, 2017

This PDF Document contains internal hyperlinks for ease of navigation.  
For example, click on any item listed in the [Table of Contents](#) to go to that page.

- [General Description](#)
  - [User Guide](#)
- 

## Published by:

### Atop Technologies, Inc.

2F, No. 146, Sec. 1, Tung-Hsing Rd,  
30261 Chupei City,  
Hsinchu County  
Taiwan, R.O.C.

Tel: +886-3-550-8137  
Fax: +886-3-550-8131  
sales@atop.com.tw  
www.atoponline.com  
www.atop.com.tw

## Important Announcement

The information contained in this document is the property of Atop Technologies, Inc., and is supplied for the sole purpose of operation and maintenance of Atop Technologies, Inc., products.

No part of this publication is to be used for any other purposes, and it is not to be reproduced, copied, disclosed, transmitted, stored in a retrieval system, or translated into any human or computer language, in any form, by any means, in whole or in part, without the prior explicit written consent of Atop Technologies, Inc.,

Offenders will be held liable for damages and prosecution.

All rights, including rights created by patent grant or registration of a utility model or design, are reserved.

## Disclaimer

We have checked the contents of this manual for agreement with the hardware and the software described. Since deviations cannot be precluded entirely, we cannot guarantee full agreement. However, the data in this manual is reviewed regularly and any necessary corrections will be included in subsequent editions.

Suggestions for improvement are welcome.

All other product's names referenced herein are registered trademarks of their respective companies.

## Documentation Control

<b>Author:</b>	Saowanee Saewong
<b>Revision:</b>	1.5
<b>Revision History:</b>	Logo
<b>Creation Date:</b>	23 February 2017
<b>Last Revision Date:</b>	20 December 2017
<b>Product Reference:</b>	SW5501-SW5502
<b>Document Status:</b>	Released

## Table of Contents

1	Preface .....	9
1.1	Purpose of the Manual .....	9
1.2	Who Should Use This User Manual .....	9
1.3	Supported Platform .....	9
1.4	Warranty Period .....	9
1.5	Manufacturers Federal Communication Commission Declaration of Conformity Statement.....	9
1.6	European Community, Switzerland, Norway, Iceland, and Liechtenstein .....	10
1.7	UL Notice for Power supplier .....	11
2	Introduction .....	12
2.1	Product Overview .....	12
2.2	Features .....	13
3	Getting Started .....	14
3.1	Packing List .....	14
3.2	Optional Accessories.....	14
3.3	Ordering Information .....	15
3.4	Appearance: front-power-side panels .....	15
3.5	Serial Pin Assignments .....	17
3.5.1	D-Sub9 (DB9).....	17
3.5.2	Terminal Block (TB5).....	18
3.6	First time installation.....	18
3.7	Factory Default Settings .....	19
4	Configuration and setup .....	20
4.1	Change basic settings with Device Management Utility .....	20
4.2	Advanced configuration via Web Interface .....	25
4.2.1	Operation Mode.....	27
4.2.2	Overview .....	30
4.2.3	Wireless Status .....	31
4.2.4	Site Monitor .....	31
4.3	Web configuration - Network settings .....	33
4.4	Web configuration – Wireless Settings .....	35
4.4.1	Wireless Profiles.....	35
4.4.2	Basic Settings.....	38
4.4.3	Advanced Settings .....	42
4.5	Web configuration – Serial .....	44
4.5.1	COM Port Overview .....	44
4.5.2	COM Configuration.....	45
4.5.3	COM Configuration: Advanced Settings .....	46
4.6	Web configuration - SNMP/Alert Settings .....	49
4.7	Web configuration - E-mail Settings.....	50
4.8	Web configuration - Log Settings .....	52
4.8.1	System Log Settings .....	52
4.8.2	COM Log Settings .....	53
4.8.3	Event Log .....	54
4.8.4	COM DataLog .....	55
4.9	Web configuration – System Setup.....	56
4.9.1	Date/Time Settings.....	56
4.9.2	Admin Settings .....	57
4.9.3	Firmware upgrade .....	58
4.9.4	Backup/Restore Settings.....	58
4.9.5	Management List.....	59

---

4.9.6	Ping .....	60
4.10	Web configuration – Reboot and Restore to default Settings .....	61
5	Link modes and Applications.....	62
5.1	Link Mode Configuration .....	62
5.1.1	Link Mode: Configure SW550X as a TCP Server .....	62
5.1.2	Link Mode: Configure SW550X as a TCP Client .....	66
5.1.3	Link Mode: Configure SW550X in UDP .....	68
5.2	Link Mode Applications .....	71
5.2.1	TCP Server Application: Enable VirtualCOM.....	71
5.2.2	TCP Server Application: Enable RFC 2217 through Virtual COM .....	72
5.2.3	TCP Client Application: Enable Virtual COM .....	72
5.2.4	TCP Client Application: Enable RFC 2217 through Virtual COM .....	73
5.2.5	TCP Client Application: Configure SW550X as a Pair Connection Master.....	73
5.2.6	TCP Client Application: Configure SW550X as a Pair Connection Slave.....	74
5.2.7	TCP Server Application: Enable Reverse Telnet .....	74
5.2.8	UDP Application: Multi-Point Pair Connection .....	75
5.2.9	TCP Server Application: Multiple TCP Connections .....	77
5.2.10	TCP Server Application: Multi-Point TCP Pair Connections .....	77
5.3	Wireless Topology.....	78
5.3.1	Configure SW550X as a Wireless Ad-Hoc Peer .....	78
5.3.2	Configure SW550X as a Wireless Client in the Infrastructure mode (PSK).....	80
5.3.3	Click-2-Go .....	82
5.3.4	Configure SW550X as a Wireless Client in the Infrastructure mode (PEAP-MSCHAPv2).....	83
6	VCOM installation and troubleshooting .....	84
6.1	Enabling VCOM.....	84
6.1.1	VCOM Driver Setup.....	85
6.1.2	Limitation .....	86
6.1.3	Install .....	86
6.1.4	Uninstall.....	86
6.2	Enable VCOM in Serial Device Servers and Select VCOM in Windows .....	87
6.2.1	Enable VCOM in Serial Device Servers.....	87
6.2.2	Running Serial/IP Software Utility in Windows.....	87
6.2.3	Configuring VCOM ports .....	89
6.3	Exceptions.....	92
6.4	Using Serial/IP Monitor.....	96
6.4.1	Opening the Port Monitor .....	96
6.4.2	Activity Panel .....	96
6.4.3	Trace Panel .....	97
6.5	Serial/IP Advanced Settings.....	99
6.5.1	Advanced Settings Options .....	99
6.5.2	Using Serial/IP with a Proxy Server .....	100
7	Specifications.....	101
7.1	Hardware Specifications .....	101
7.1.1	Models of SW550X Series .....	101
7.1.2	Physical Characteristics .....	101
7.1.3	LED Indicators .....	101
7.1.4	Signal LEDs.....	102
7.1.5	Dip Switch (SW5501).....	102
7.1.6	Dip Switch (SW5502) .....	102
7.1.7	Wireless Specifications .....	103
7.1.8	Frequency Range: .....	103
7.1.9	Data Rate: .....	103
7.1.10	Output Power.....	104
7.1.11	Receiver Sensitivity.....	104

7.1.12	Security.....	106
7.1.13	Regulatory Requirements .....	106
7.1.14	Environmental Limits .....	107
7.1.15	Other.....	107
7.2	Software Specifications.....	107
8	Emergency System Recovery.....	108
9	Warranty .....	109

## Table of Figures

Figure 2.1	An Application of Wireless Serial Device Server in WLAN.....	12
Figure 3.1	Front Panel of SW5501.....	15
Figure 3.2	Front Panel of SW5502.....	15
Figure 3.3	Front Panel of SW5501-TB/Sis.....	16
Figure 3.4	Front Panel of SW5502-TB/Sis.....	16
Figure 3.5	Power Panel of all SW550X Series .....	16
Figure 3.6	Rear view of SW550X Series.....	17
Figure 3.7	Din-Rail Mount of SW550X.....	17
Figure 4.1	User Interface of Device Management© lists a SW550X device in wireless client mode .....	20
Figure 4.2	Administrator Login .....	21
Figure 4.3	Notification in case that the SW550X device is in different subnetwork from your PC.....	21
Figure 4.4	Pop-up window indicates a successful login .....	21
Figure 4.5	Mark of login device in the Caution column .....	22
Figure 4.6	Notification of unsuccessful login when the interface is either down or unreachable.....	22
Figure 4.7	Pull-down Menu of Configuration and Network.....	23
Figure 4.8	Pop-up Windows of Network Setting .....	23
Figure 4.9	Authorization for Change.....	24
Figure 4.10	Waiting Notification for Restarting Device .....	24
Figure 4.11	Authentication Pop-up Windows.....	25
Figure 4.12	User Interface of Web Configuration .....	26
Figure 4.13	Menu-tree of All Available Modes and Options of SW550X Series .....	26
Figure 4.14	Configuration Page of Operation Mode with Wireless Client Setting .....	27
Figure 4.15	Waiting Message.....	28
Figure 4.16	Completion of the settings and counting down for a page reload .....	28
Figure 4.17	AP Client Operation Mode Setting .....	29
Figure 4.18	Overview Information Page of an SW550X Device .....	30
Figure 4.19	Wireless Status page shows current information of SW550X. ....	31
Figure 4.20	Transition page during the gathering of surrounding wireless network information. ....	32
Figure 4.21	Results of a Site Monitoring of SW550X Series.....	32
Figure 4.22	Network Settings Page (Wireless Client Mode).....	33
Figure 4.23	Network Settings Page for Bridged Interface (AP Client Mode).....	34
Figure 4.24	Enabling Wireless Profile Option to Add New Access Point.....	35
Figure 4.25	Basic Setting List Webpage after Clicking Add Button.....	36
Figure 4.26	Wireless Profile Page .....	37
Figure 4.27	Basic Settings for Wireless Connection when Wireless Profile is Enabled .....	38
Figure 4.28	Basic Settings for Wireless Connection when Wireless Profile is Disabled. ....	39
Figure 4.29	Results of network scanning when uses "scan network" buttons.....	41
Figure 4.30	Result when there is no wireless network available in the area. ....	41

---

Figure 4.31	Wireless Advanced Settings Page when Wireless Profile is Disabled and Topology is set to infrastructure.....	42
Figure 4.32	Wireless Advanced Settings Page when Wireless Profile is Enabled.....	43
Figure 4.33	COM 1 Port Setting Page .....	44
Figure 4.34	Serial Settings Part of COM Port .....	45
Figure 4.35	Advanced COM Port Settings Page .....	46
Figure 4.36	SNMP/Alert Settings Page .....	49
Figure 4.37	E-mail Settings Page .....	51
Figure 4.38	Sending Test E-mail Failed .....	51
Figure 4.39	System Log Settings Page.....	52
Figure 4.40	COM Log Settings Page .....	53
Figure 4.41	Event Log Page .....	54
Figure 4.42	COM Datalog Page.....	55
Figure 4.43	Date/Time Settings Page.....	56
Figure 4.44	Admin Settings Page .....	57
Figure 4.45	Firmware Upgrade Page.....	58
Figure 4.46	Backup/Restore Setting Page .....	59
Figure 4.47	Management List Page .....	59
Figure 4.48	Successful Ping with No Packet Loss.....	60
Figure 4.49	Unsuccessful Ping with 100% Packet Loss .....	60
Figure 4.50	Reboot Page .....	61
Figure 4.51	Pop-up Windows while Rebooting SW550X with Reloading Countdown in Seconds .....	61
Figure 5.1	Link Mode Options for COM 1 Port.....	62
Figure 5.2	An Example of TCP Server Link Mode .....	62
Figure 5.3	Connection Settings for TCP Server Link Mode .....	63
Figure 5.4	TCP Server Link Mode Settings under COM 1 Page .....	64
Figure 5.5	An Example of TCP Client Link Mode .....	66
Figure 5.6	Connection Settings for TCP Client Link Mode .....	66
Figure 5.7	TCP Client Link Mode Settings under COM 1 Page.....	67
Figure 5.8	An Example of UDP Link Mode .....	68
Figure 5.9	Connection Setting for UDP Link Mode .....	69
Figure 5.10	UDP Link Mode Settings under COM 1 Page.....	69
Figure 5.11	Virtual COM Application in TCP Server Link Mode .....	71
Figure 5.12	Virtual COM Application in TCP Client Link Mode.....	72
Figure 5.13	Pair Connection Master Application in TCP Server Link Mode .....	73
Figure 5.14	Pair Connection Slave Application in TCP Client Link Mode.....	74
Figure 5.15	Reverse Telnet Application in TCP Server Link Mode .....	75
Figure 5.16	An Example of Network Topology for Multi-Point Pair Connection in UDP Link Mode .....	76
Figure 5.17	Setting of Multiple TCP Connection Application via Maximum Connection Option .....	77
Figure 5.18	An Example of Network Topology for Multi-Point Pair Connection in TCP Link Mode .....	78
Figure 5.19	Wireless Ad-Hoc Peer Settings for SW550X.....	79
Figure 5.20	Wireless Client with WPA2-PSK Security Settings for SW550X.....	81
Figure 5.21	Wireless Client with PEAP Security Settings for SW550X .....	83
Figure 6.1	Enabled Virtual COM Application in TCP Server Link Mode.....	84
Figure 6.2	Enabled Virtual COM Application in TCP Client Link Mode.....	84
Figure 6.3	An Example Diagram of Virtual COM Application over TCP/IP Network .....	85
Figure 6.4	Enable Virtual COM Application for COM 2 in TCP Server Link Mode .....	87
Figure 6.5	Serial/IP Tray Icon on Windows Notification Area .....	88
Figure 6.6	A Pop-up Window for Selecting Virtual COM Ports.....	88
Figure 6.7	Serial/IP Control Panel Window .....	89
Figure 6.8	Configuring Virtual COM 2 Port as TCP Client.....	90
Figure 6.9	Configuration Wizard Window for COM 1 .....	91
Figure 6.10	Timeout Warning on VCOM Connection .....	92
Figure 6.11	Error of Client not licensed for this server.....	93
Figure 6.12	Licensing Issue of Serial/IP Utility Software .....	93
Figure 6.13	VCOM Authentication failed due to Missing Username/Password .....	94

Figure 6.14	VCOM Authentication failed due to incorrect Username and/or Password .....	94
Figure 6.15	VCOM Authentication failed due to disabled VCOM Authentication on SW550X .....	95
Figure 6.16	Activity Panel of Serial/IP Port Monitor.....	96
Figure 6.17	Trace Panel of Serial/IP Port Monitor .....	97
Figure 6.18	Serial/IP Advanced Settings Window .....	99
Figure 6.18	Proxy Server Tab under Serial/IP Advanced Settings .....	100

## List of Tables

Table 3.1	Packing List .....	14
Table 3.2	Optional Accessories.....	14
Table 3.3	Device Ordering Information .....	15
Table 3.4	Factory Default Network Settings.....	19
Table 3.5	SW550X Series Factory Default Settings .....	19
Table 4.1	Common Buttons in Web Configuration Menu.....	27
Table 4.2	Default Settings in Infrastructure Mode:.....	38
Table 4.3	Default Settings in Ad Hoc Mode:.....	38
Table 5.1	An Example of Multi-Point Pair Connection's Parameter Settings for UDP Link Mode.....	76
Table 5.2	An Example of Multi-Point Pair Connection's Parameter Settings for TCP Link Mode .....	77
Table 5.3	Summary of Parameter Settings for Wireless Ad-Hoc Peer with WEP Security .....	79
Table 5.4	Summary of Parameter Settings for Wireless Client in Infrastructure Topology with WPA2-PSK Security .....	82
Table 5.5	Wireless Client-Infrastructure Topology Parameters with WPA2 (PEAP-MSCHAPv2) Security.....	83
Table 5.5	SW550X series and their interfaces.....	101
Table 5.5	Physical Characteristics of SW550X Series.....	101
Table 5.5	Descriptions of LED Status Indicators.....	101
Table 5.5	Interpretation of SW550X's Operation via Front Panel LEDs .....	102
Table 5.5	Dip Switch Functions of SW5501 .....	102
Table 5.5	Dip Switch Function of SW5502.....	102
Table 5.5	Wireless Interface Specification of SW550X Series .....	103
Table 5.5	Operating Frequencies in Different Regions at 2.4GHz and 5GHz.....	103
Table 5.5	Supported Data Rate for Wireless Interface under IEEE 802.11 Standards .....	103
Table 5.5	Maximum Output Power of Wireless Interface under IEEE 802.11Standards.....	104
Table 5.5	Receiver Sensitivity of Wireless Interface under IEEE 802.11 Standards .....	104
Table 5.5	Conformed Radio Frequency and Electromagnetic Standards.....	106
Table 5.5	Conformed Electrical Standards .....	106
Table 5.5	Software Specifications .....	107



# 1 Preface

---

## 1.1 *Purpose of the Manual*

---

This manual supports you during the installation and configuring of Device Management Utility®, as well as it explains some technical options available with the mentioned product. As such, it contains some advanced network management knowledge, instructions, examples, guidelines and general theories designed to help users manage this device and its corresponding software. A background in general theory is necessary when reading it. Please refer to the Glossary for technical terms and abbreviations (if any).

## 1.2 *Who Should Use This User Manual*

---

This manual is to be used by qualified network personnel or support technicians who are familiar with network operations. It might be useful for system programmers or network planners as well. This manual also provides helpful and handy information for first time users. For any related problems, please contact your local distributor. If they are unable to assist you, please redirect your inquiries to [www.atop.com.tw](http://www.atop.com.tw) or [www.atoponline.com](http://www.atoponline.com).

## 1.3 *Supported Platform*

---

This manual is designed for the SW550X Industrial Wireless Serial Device Server Series and that model only.

## 1.4 *Warranty Period*

---

Atop provides a **5-year limited warranty** for SW550X Industrial Wireless Serial Device Server Series.

## 1.5 *Manufacturers Federal Communication Commission Declaration of Conformity Statement*

---

**Model: SW550X Industrial Wireless Serial Device Server Series**

**NOTE:** This equipment has been tested and found to comply with the limits for a Class A digital device, pursuant to Part 15 of the FCC Rules. These limits are designed to provide reasonable protection against harmful interference in a residential installation. This equipment generates, uses and can radiate radio frequency energy and, if not installed and used in accordance with the instructions, may cause harmful interference to radio communications. However, there is no guarantee that interference will not occur in a particular installation. If this equipment does cause harmful interference to radio or television reception, which can be determined by turning the equipment off and on, the user is encouraged to try to correct the interference by one of the following measures:

- Reorient or relocate the receiving antenna.
- Increase the separation between the equipment and receiver.
- Connect the equipment into an outlet on a circuit different from that to which the receiver is connected.

- Consult the dealer or an experienced radio/TV technician for help.

This device complies with Part 15 of the FCC Rules. Operation is subject to the following two conditions:

1. This device may not cause harmful interference, and
2. This device must accept any interference received, including interference that may cause undesired operation.

This device and its antenna(s) must not be co-located or operating in conjunction with any other antenna or transmitter except in accordance with FCC multi-transmitter product procedures.

**FCC Caution:** Any changes or modifications not expressly approved by the party responsible for compliance could void the user's authority to operate this equipment. For product available in the USA/Canada market, only channel 1~11 can be operated. Selection of other channels is not possible.

- This device is restricted to indoor use when operated in the 5.15 to 5.25 GHz frequency range use.
- FCC requires this product to be used indoors for the frequency range 5.15 to 5.25 GHz to reduce the potential for harmful interference to co-channel mobile satellite systems.

**FCC Radiation Exposure Statement:** This equipment complies with FCC radiation exposure limits set forth for an uncontrolled environment. This equipment should be installed and operated with a minimum distance of 20cm between the radiator and human body.

---

## 1.6 *European Community, Switzerland, Norway, Iceland, and Liechtenstein*

---

**Model:** SW550X Industrial Wireless Serial Device Server Series

### **Declaration of Conformity with regard to the R&TTE Directive 2014/53/EC**

This equipment is in compliance with the essential requirements and other relevant provisions of 2014/53/EC. The following standards were applied:

- EMC : EN 301 489-1 v1.9.2 (2011-09), EN 301 489-17 v2.2.1 (2012-09)
- Radio : 47 CFR FCC Part 15 Subpart C § 15.247, 47 CFR FCC Part 15 Subpart E § 15.407
- EN300 328 v1.8.1 (2012-06), EN301.893 v1.7.1 (2012-06)
- EMF: 47 CFR FCC Pat 2 Subpart J, section 2.1091, EN 62311:2008 and EN50385:2002
- Health & Safety: EN60950-1: 2001; EN 50385: 2002

The conformity assessment procedure referred to in Article 10.4 and Annex III of Directive 2014/53/EC has been followed.

**Note :** This equipment is intended to be used in all EU and EFTA countries. Outdoor use may be restricted to certain frequencies and/or may require a license for operation. For more details, contact Atop Technologies, Inc.

### **European Union**

This system has been evaluated for RF exposure for Humans in reference to the ICNIRP (International Commission on Non-Ionizing Radiation Protection) limits. The evaluation was based on the EN 50385 Product Standard to

Demonstrate Compliance of Radio Base Stations and Fixed Terminals for Wireless Telecommunications Systems with basic restrictions or reference levels related to Human Exposure to Radio Frequency Electromagnetic Fields from 300 MHz to 40 GHz. The minimum separation distance from the antenna to general bystander is 20cm (7.9 inches).

---

## **1.7**      ***UL Notice for Power supplier***

---

The SW550X Series products are intended to be supplied by a listed power unit marked with "LPS" (Limited Power Source), or "Class 2" and output rate of 9~48 VDC, 1.0 Ampere minimum, or use the recommended power supply listed in Table 3.2 Optional Accessories.

## 2 Introduction

### 2.1 Product Overview

The SW550X Industrial Wireless Serial Device Server is designed to provide wireless connectivity to clients and serial devices, thus creating a complete solution for your industrial wireless networking. The SW550X series can be operated as a wireless client with the ability to connect serial device to Wireless Local Area Network (WLAN) or Local Area Network (LAN) and as AP client to bridge between WLAN and LAN.

The SW550X Series support IEEE 802.11a/b/g/n wireless connectivity standards, which can be operated in both 2.4GHz and 5GHz bands. It acts as a server for serial devices that are connected to its ports in order to transparently connect to other devices in the wireless network or can be reached by other wireless devices. Supported interfaces of serial devices include RS-232, RS-422, and RS-485.

As an example, user can connect serial devices to a **Wireless Serial Device Server (SW550X)** and control them through **Wireless Networking Device** such as Wireless Access Point (AW5500) in wireless local area network (WLAN). An example in Figure 1.1 illustrates how to connect serial devices to a wireless local area network or a backbone network. The SW550X Industrial Wireless Serial Device Server provides several functionalities to support mobile and wireless networking.

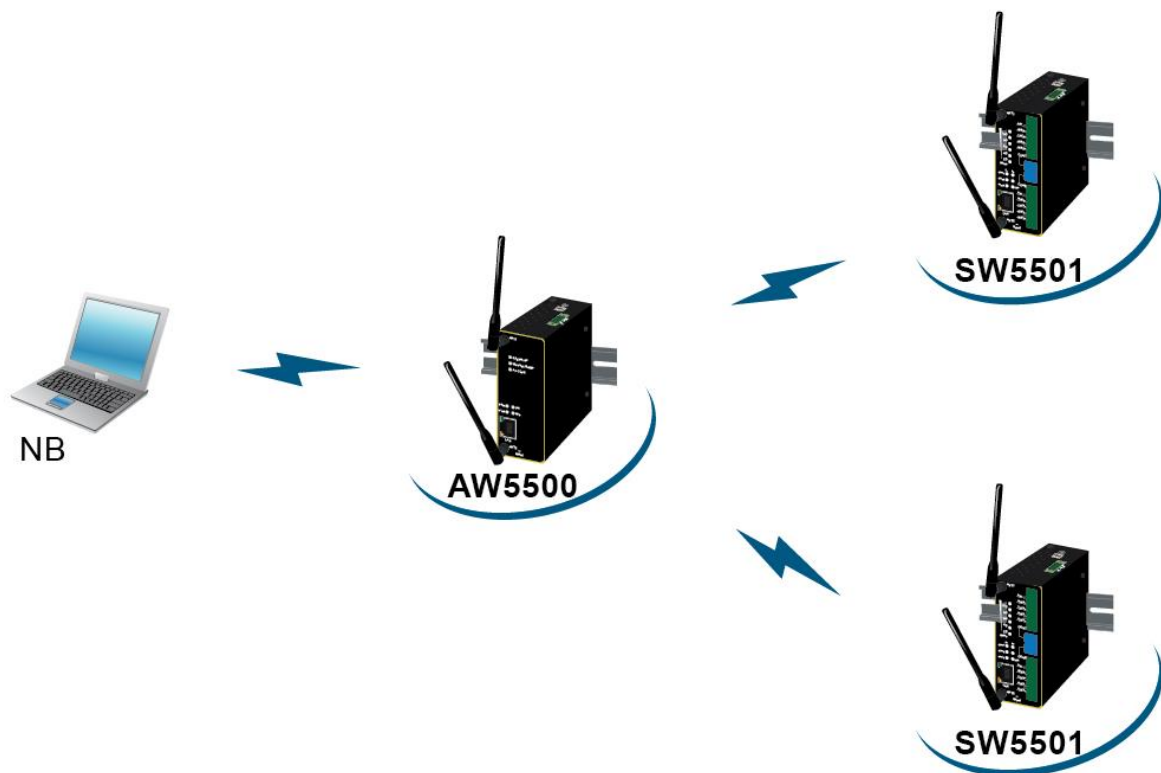

Figure 2.1 An Application of Wireless Serial Device Server in WLAN

---

## 2.2 Features

---

SW550X Series' small size but powerful architecture makes it a perfect choice for industrial/manufacturing needs in which size is a decisive factor. It rewards our customers with superb connectivity withstanding all the harshness in your environment of choice.

The key characteristics of SW550X are:

- Support of the most popular wireless local area network standards IEEE 802.11a/b/g/n
- Support of 5 GHz Industrial, Scientific and Medical (ISM) band operating frequency to reduce interference in 2.4 GHz ISM band with other wireless devices
- Certified wireless equipment by FCC (United States), ETSI (Europe), and NCC (Taiwan)
- Dual antennas offer better wireless coverage and reduce wireless blind spots
- Embedded PCB coating protection
- Easy configuration through embedded web server interface or Atop's Windows®-based configuration utility program called **Device Management®**
- Firmware upgradable through embedded web server interface or Atop's **Device Management®**

---

### Caution

From here on, extreme caution must be exercised.

---



Never install or work on electrical or cabling during periods of lightning activity. Never connect or disconnect power when hazardous gases are present.



**WARNING:** Disconnect the power and allow unit to cool for 5 minutes before touching.

## 3 Getting Started

### 3.1 Packing List

Inside the purchased package, you will find the following items:

Table 3.1 Packing List

Item	Quantity	Description
SW550X Series	1	Industrial Wireless Serial Device Server
Antenna	2	3~5 dBi antenna
Terminal Block		3-pin 5.08mm Lockable Terminal Block (TB3) × 1 5-pin 5.08mm Lockable Terminal Block (TB5) × 1 (SW5501-TB/SW5501-Sis only) 5-pin 5.08mm Lockable Terminal Block (TB5) × 2 (SW5502-TB/SW5502-Sis only)
Documentation	1	Hardware Installation Guide (Warranty Card is included)
Mounting Kit	1	DIN-Rail Kit (Already mounted on the device)

**Note:** Please notify your sales representative if any of the above items is missing or damaged in any form upon delivery. If your sales representative is unable to satisfy your enquiries, please contact us directly.

### 3.2 Optional Accessories

The following table lists optional accessories for SW550X series.

Table 3.2 Optional Accessories

Item	Description
UN315-1212(US-LDC)	Y-Type (5.08mm) power adapter, 100-240VAC input, 1.25A @ 12VDC output, US plug
UNE315-1212(EU-LDC)	Y-Type (5.08mm) power adapter, 100-240VAC input, 1.25A @ 12VDC output, EU plug
ADP-DB9(F)-TB5	Female DB9 to Female 3.81 TB5 Converter
WMK-454-Black	Black Aluminum Wall Mount Kit

### 3.3 Ordering Information

Please refer to the following product codes to place an order.

Table 3.3 Device Ordering Information

Model Name	P/N	Description
SW5501	1P1SW550100001G	1-port Industrial Wireless Serial Device Server, DB9
SW5501-TB	1P1SW5501TB001G	1-port Industrial Wireless Serial Device Server, TB5
SW5501-Sis	1P1SW5501SIS01G	1-port Industrial Wireless Serial Device Server, TB5 with serial isolation
SW5502	1P1SW550200001G	2-port Industrial Wireless Serial Device Server, DB9
SW5502-TB	1P1SW5502TB001G	2-port Industrial Wireless Serial Device Server, TB5
SW5502-Sis	1P1SW5502SIS01G	2-port Industrial Wireless Serial Device Server, TB5 with serial isolation

### 3.4 Appearance: front-power-side panels

The **front panels** of different models of SW550X series are shown in the following figures. Note that the **power panel** and the **rear panel** are the same for all models. Note that the detailed description of LEDs and DIP switch on the front panel can be found in [Chapter 7.1](#) below.



Figure 3.1 Front Panel of SW5501



Figure 3.2 Front Panel of SW5502



Figure 3.3 Front Panel of SW5501-TB/Sis

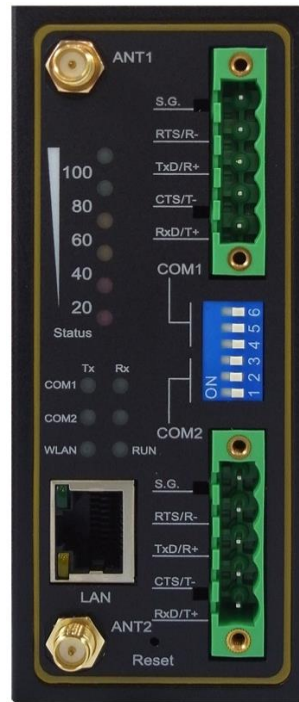

Figure 3.4 Front Panel of SW5502-TB/Sis



Figure 3.5 Power Panel of all SW550X Series

**Note:** The blue DIP switch on the front panel of SW550X can be used to adjust different values for pull-high or pull-low termination resistors on the RS-485 COM ports. If the RS-485 network range is shorter than 100 meters, the termination resistors are not required (by setting the DIP switch to termination off). Otherwise, it may be necessary to insert termination resistors (by setting the DIP switch to termination on) at both ends of RS-485 network to improve signal quality. [Table 7.5](#) and [Table 7.6](#) summarize the functionalities of the DIP switches for COM1 and COM2 on their SW550X series.

The **rear panel** (where you can mount the device on a rail or to the wall) is shown in figure below, together with a simple mounting instruction.





Figure 3.6 Rear view of SW550X Series

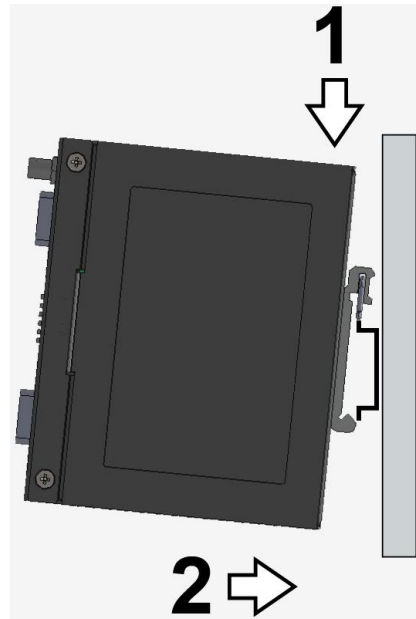
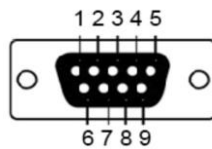

Figure 3.7 Din-Rail Mount of SW550X

## 3.5 Serial Pin Assignments

### 3.5.1 D-Sub9 (DB9)



Pin#	RS-232 Full Duplex	RS-422/4-Wire RS-485 Full Duplex	2-Wire RS-485 Half Duplex
1	DCD	N/A	N/A
2	RXD	TXD+	N/A (reserved)
3	TXD	RXD+	DATA+
4	DTR	N/A	N/A
5	SG (Signal Ground)	SG (Signal Ground)	SG (Signal Ground)
6	DSR	N/A	N/A
7	RTS	RXD-	DATA-
8	CTS	TXD-	N/A (reserved)
9	RI	N/A	N/A

### 3.5.2 Terminal Block (TB5)

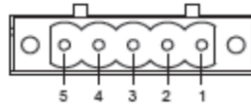

Pin#	RS-232 Full Duplex	4-W RS-422/RS-485 Full Duplex	2-W RS-485 Half Duplex
1	SG	SG	SG
2	RTS	R-	DATA-
3	TxD	R+	DATA+
4	CTS	T-	N/A
5	RxD	T+	N/A

## 3.6 First time installation

Before installing the device, please adhere to all safety procedures described below, Atop will not be held liable for any damages to property or personal injuries resulting from the installation or overall use of the device. **Do not attempt to manipulate the product in any way if unsure of the steps described here<sup>1</sup>, in such cases please contact your dealer immediately.**

1. Prepare the necessary cables, DC adapter, power cord, LAN cable, serial cable, etc; **do not connect the unit yet.**
2. Install both antennas to the SMA connectors (gold connectors) in the front panel of SW550X device. Note that the antenna's connectors are female reverse-polarity (RP) SMA type. The gains of the antennas are 3dBi at 2.4GHz and 5dBi at 5GHz. Once installed the device to a rail or your desired location, do not put them parallel otherwise their signal will interfere with each other. Please see the recommended antennas setup for SW550X in the Hardware Installation Guide.
3. Plug the power source to the unit, starting from the ground (It is a screw close to the power terminal block.) and then the 3-Pin power terminal block on the power panel in Figure 3.5. A recommended power adapter (such as US315-1212 power adapter listed in Table 3.2) with 3-Pin terminal block can be connected to the power terminal block. You will hear a long beep with all LEDs turn on and after a few second you will hear a shot beep twice and the RUN LED will start blinking slowly. If the device's wireless interface is working properly, the WLAN LED will also turn on and start blinking once in a while. Device's STATUS LEDs will also start running too from bottom LED to the top LED.
4. Note that although internal grounding has been done inside, in order to ensure overall maximum performance and protection of your device it is strongly advised to properly connect the grounding. Please choose **only one** of the grounding connections either connecting the ground to the screw on the power panel or to the Frame Ground (F.G.) pin of the 3-Pin terminal block.
5. Place the device in the desired location, which is dry and free from dirt or corrosive vapors, and connect it to a **LAN** via an **Ethernet cable** with an **RJ45 connector**.
6. Connect your computer to the **LAN** network. Default configurations will be addressed later in [Chapter 3.7 below](#).

**Note<sup>1</sup>:** Please consult your Hardware Installation Guide (leaflet available in your package) for more information when attempting an installation. Also, please follow all safety procedures when doing so.

### 3.7 Factory Default Settings

Upon arrival, the device is set with factory default settings. The SW550X Series comes with two different IP addresses for LAN and WLAN as shown below.

Table 3.4 Factory Default Network Settings

Interface	Device IP	Subnet mask	Gateway IP	DNS1
LAN	10.0.50.100	255.255.0.0	10.0.0.254	168.95.1.1
WLAN	192.168.1.1	255.255.255.0	192.168.1.254	

Other relevant factory default settings are summarized below.

Table 3.5 SW550X Series Factory Default Settings

Parameter	Default Values
<b>Security</b>	
User Name	admin
Password	default
<b>Serial</b>	
COM1	RS-232 (RS-422 for Sis models), 9600 bps, 8 data bits, No Parity bit, 1 stop bit, No Flow Control Packet Delimiter timer: Auto
COM2	
<b>SNMP</b>	
SysName of SNMP	0060E9XXXXXX
SysLocation of SNMP	Location
SysContact of SNMP	Contact
SNMP	Disabled
Read Community	public
Write Community	private
SNMP Trap Server	0.0.0.0

**Note:** you can press the “Reset” button on the front panel for 5 seconds to restore the SW550X Series to the factory default settings.

## 4 Configuration and setup

### 4.1 Change basic settings with Device Management Utility

**Note:** Advanced settings are not possible via Device Management Utility. This can be used to locate, access, modify network parameters, change login credentials or update firmware. For device-specific settings, please use Web Interface, as described in [Chapter 4.2 below](#).

First, please install our configuration utility program called **Device Management Utility** (formerly **Serial Manager**) that comes with the Product CD or can be downloaded from our websites ([www.atop.com.tw](http://www.atop.com.tw) or [www.atoponline.com](http://www.atoponline.com)).

For more information on how to install **Device Management Utility**, please refer to the manual that comes in the Product CD or that is available online. After you start the utility, SW550X Industrial Wireless Serial Device Server will be automatically detected if this is already connected to the same subnet as your PC and will be listed on the **Device Management Utility's** window.

Alternatively, if you did not see your SW550X device on your network, press “**Rescan**” icon (first icon on the icon bar). A list of devices including your SW550X device currently connected to the network will be shown in the window of **Device Management**© as shown in the Figure below.

Important information about the SW550X device such as the IP address, MAC address, etc are going to be displayed as well. Note that a simple way to configure a new SW550X device is to set a static IP for your personal computer to the same subnet (i.e. 10.0.50.XXX) as the default IP address of the LAN connection (i.e. 10.0.50.100).

Note: in the Figure below the SW5502 device appears with two lines because it has been set to operate in wireless client mode as two different IP addresses and MAC addresses are available. If, otherwise, SW5502 is set to operate in AP client mode, it will show up on the Device Management with only one IP address and MAC address. Details of operation modes will be presented in [Section 4.4 below](#).

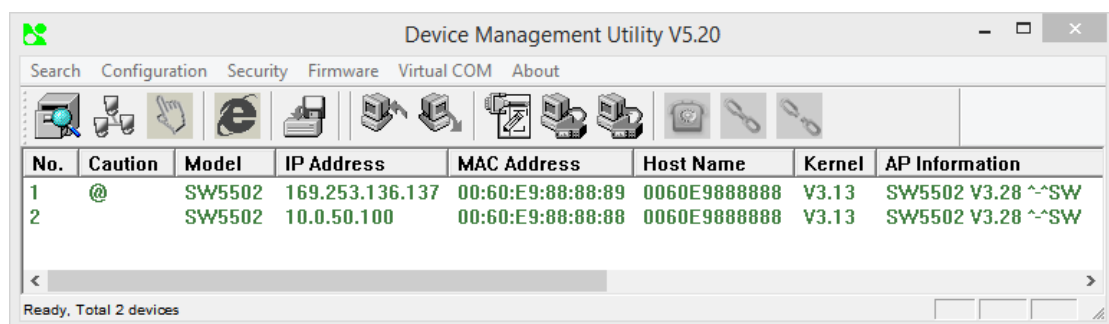

Figure 4.1 User Interface of Device Management© lists a SW550X device in wireless client mode.

After selecting and then double-clicking the device’s name on the list (such as SW5502 with IP address 10.0.50.100), a window will pop-up and prompt you to enter username and password.

**Note:** the default username is “*admin*” and the password is “*default*”, see Factory Defaults for more information), then click “**Login**” button as shown in the figure below.



Figure 4.2 Administrator Login

A pop-up window as shown will notify you if your personal computer and the SW550X device are on different sub-network. Click "OK" to accept the notification and return to the Device Management's window. In this case, please change the IP address of your PC so that it has the same subnet as the SW550X. Then, re-select and double-click on the device in order to login to the SW550X device again, as described in the previous paragraph.

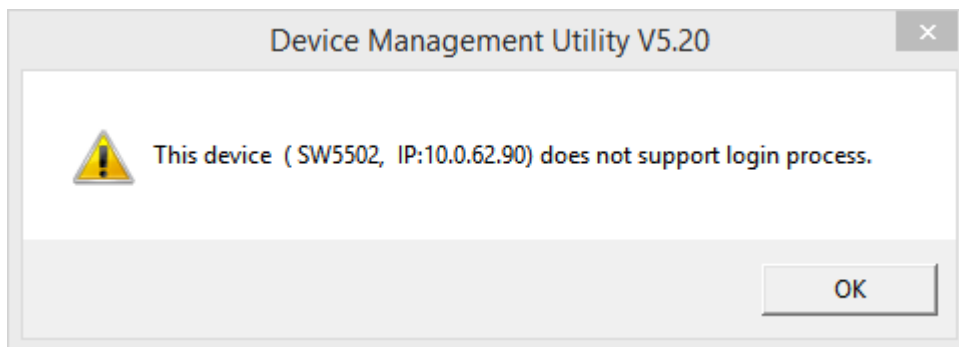

Figure 4.3 Notification in case that the SW550X device is in different subnetwork from your PC

If successful, another pop-up window will be shown when you can successfully login to the SW550X device. Click the "OK" button to proceed.

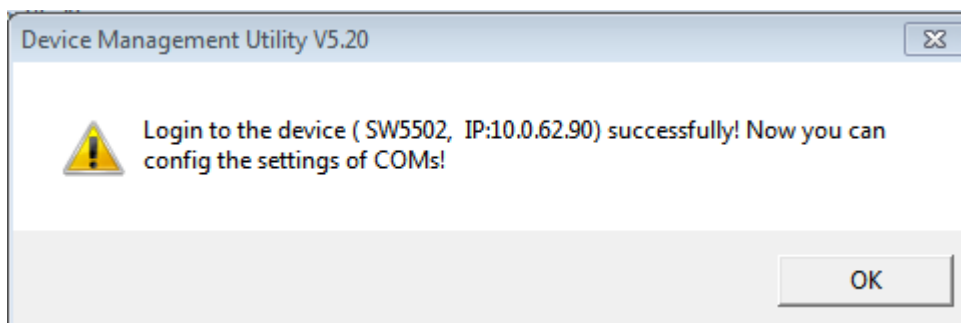

Figure 4.4 Pop-up window indicates a successful login

Then there will be a "+" symbol under the **Caution** column of the login device in **Device Management Utility** list as shown in Figure below.

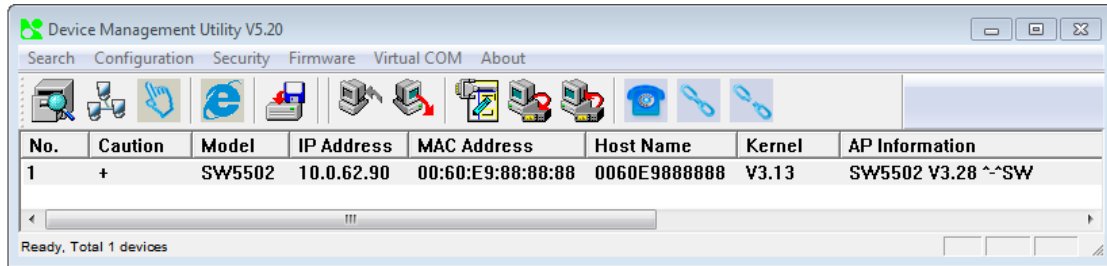

Figure 4.5 Mark of login device in the Caution column

If the device cannot be login, the system will notify you with the notification in Figure 3.6. If this happens, the user should try to check the reachability between your PC and the SW550X with 'ping' command or utility.

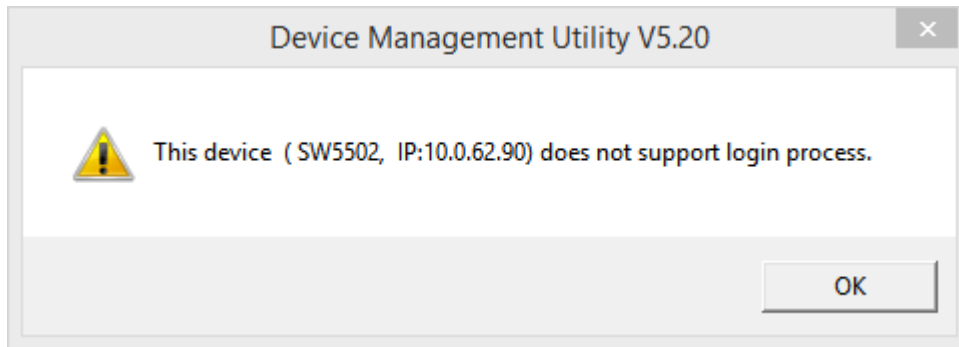

Figure 4.6 Notification of unsuccessful login when the interface is either down or unreachable.

After a successful login, the SW550X device can then be accessed and configured through the **Device Management** Utility's interface.

Note: Advanced settings are not possible via Another way of doing this is by selecting the SW550X device and then choosing the **"Config by browser"** icon from the forth icon on the icon bar or select **"Config by browser"** option from under the pull-down menu **Configuration**. Please see detail on how to configure the device via web browser in the next section.

Sometime the SW550X device might not be in the same subnet as your PC; therefore, you will have to use our utility to locate it in your virtual environment. To configure each device, click the selected SW550X device (default IP: 10.0.50.100) in the list of **Device Management**©, and click **"Configuration → Network..."** (or Ctrl+N) menu on **Device Management**© as shown in **Figure 4.7** or click on the second icon called **Network** on the menu bar, and a pop-up window will appear as shown in **Figure 4.8**.

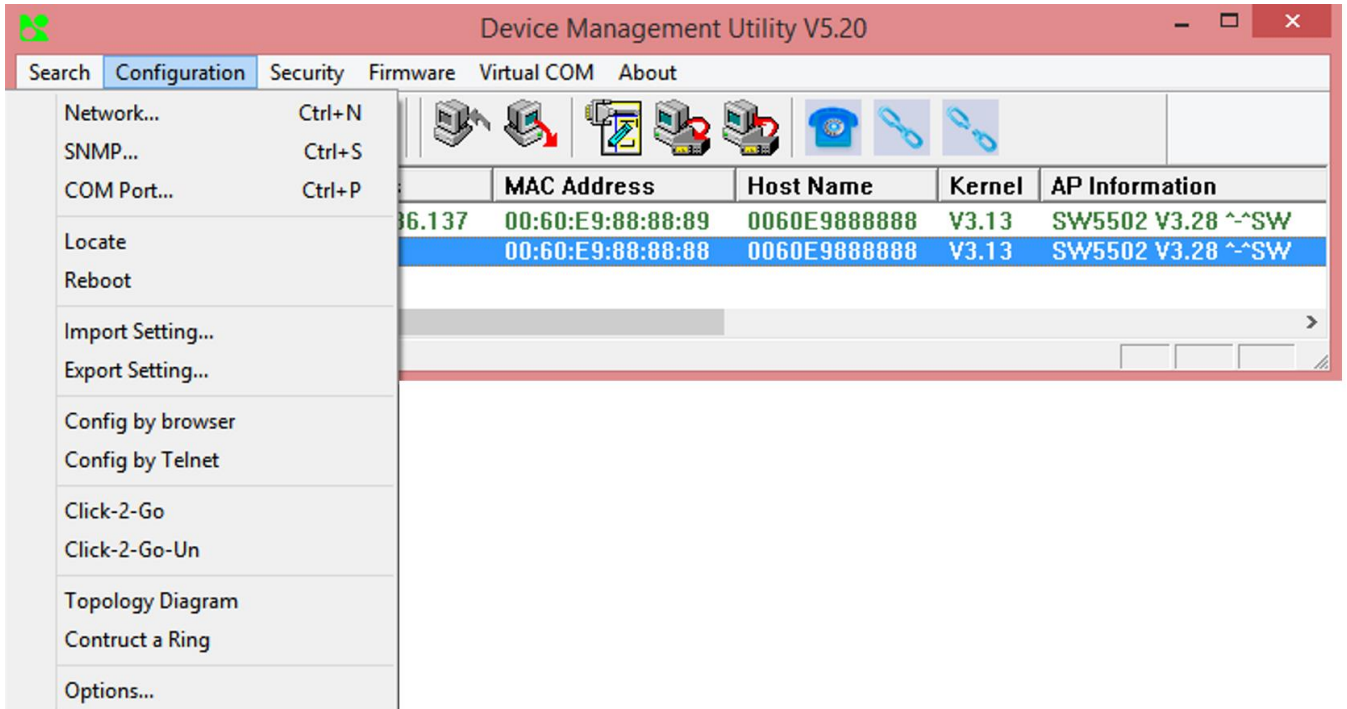

Figure 4.7 Pull-down Menu of Configuration and Network...

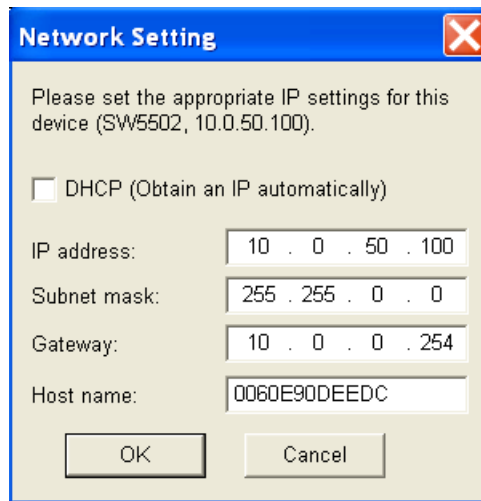

Figure 4.8 Pop-up Windows of Network Setting

You may proceed then to change the IP address, Subnet mask, and Gateway, and Host name of SW550X to avoid any IP address conflict with other hosts on your LAN or to connect the device to your existing LAN as shown in Figure 3.8. After click "OK" button, the system will prompt you for a credential to authorize the changes. That is it will ask you for the Username and the Password as shown in Figure 4.9. A pop-up window as shown in Figure 4.10 will prompt the user to wait for the change on the SW550X device.

The device will be restarted without any beep. After the device is restarted, it will beep twice to indicate that the unit is running normally. Then, the SW550X device can be found on a new IP address. It may be listed automatically by the **Device Management Utility** along with its old record or it can be found by clicking on the **Rescan** icon.

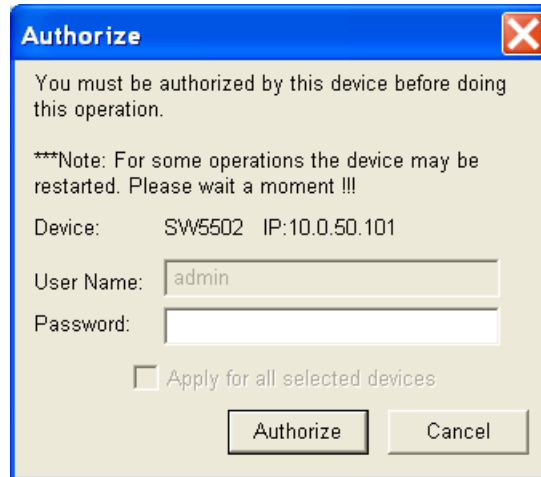

Figure 4.9 Authorization for Change

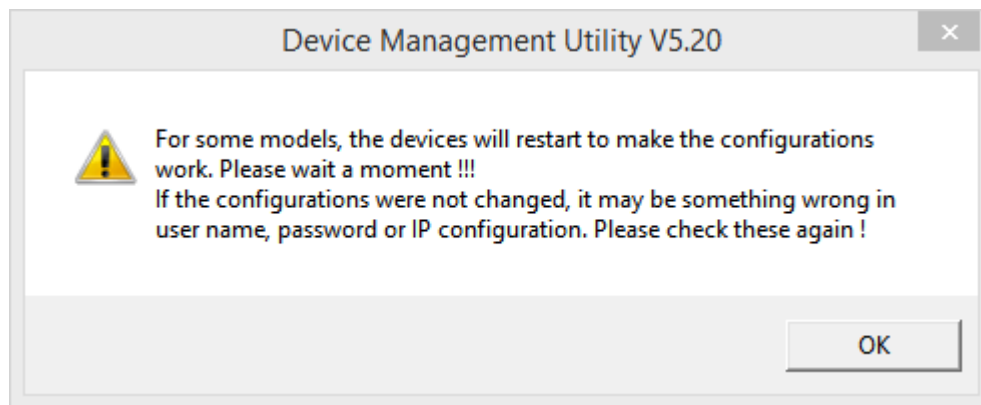

Figure 4.10 Waiting Notification for Restarting Device



## 4.2 Advanced configuration via Web Interface

The SW550X Series' user interface is designed intuitively for satisfying customers' ease of use needs.

Every SW550X device is equipped with a built-in web server. It can be accessed by using a web browser for configuring by entering the device's IP address (the default IP address is 10.0.50.100) in the URL field of your web browser. Once the device is connected to the network, it can be configured by using any web browser. An authentication request will appear as shown below when the user uses a web browser to configure the SW550X Series. If this is the first login, please enter the default **User name** as "admin" and use the default **Password** "default" then click the **OK** button to login.

Note that you can alternately launch the Web Interface with your default web browser using **Device Management Utility** by choosing the "**Config by browser**" icon from the forth icon on the icon bar or select "**Config by browser**" option from under the pull-down menu **Configuration**

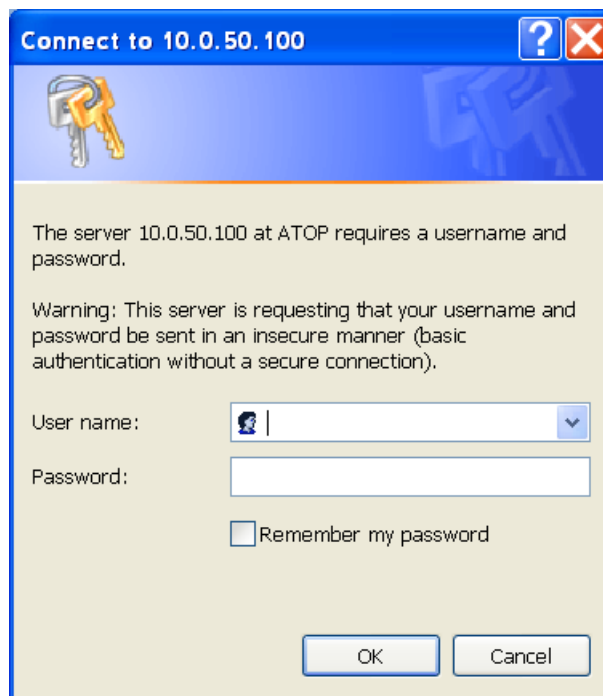

Figure 4.11 Authentication Pop-up Windows

An example of web configuration of SW550X Series is shown below.



Figure 4.12 User Interface of Web Configuration

On the left side of the screen, a menu-tree is listed with all available modes and options as shown **Figure 4.13**. On the right side of the screen, the contents of each mode/option will be displayed in a graphical format. For more information on each selection, please refer to each corresponding section throughout this manual.

- Operation Mode
- System Status
  - Overview
  - Wireless Status
  - Site Monitor
- Network Settings
- Wireless
  - Profiles
  - Basic Settings
  - Advanced Settings
- Serial
  - COM1
  - COM2
- SNMP/ALERT Settings
- E-mail Settings
- Log Settings
  - System Log Settings
  - COM Log Settings
  - Event Log
  - COM Datalog
- System Setup
  - Date/Time Settings
  - Admin Settings
  - Firmware Upgrade
  - Backup/Restore Setting
  - Management List
  - Ping
- Reboot

Figure 4.13 Menu-tree of All Available Modes and Options of SW550X Series

There are three common buttons presented in almost every web configuration menu or section as shown below.

Table 4.1 Common Buttons in Web Configuration Menu

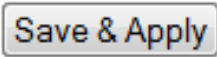
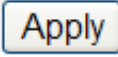
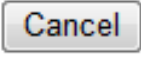
Button	Function
	Save and apply the current configuration input on the page.
	As the caption implies, it applies the current configuration immediately but it will not save into the device. Until the device is restarted, the device will return to the old parameters.
	Cancel the current configuration input and show the original setting.

#### 4.2.1 Operation Mode

The SW550X Serial Device Server Series has been designed as a Wireless Client with the ability to choose a connection between Wireless Local Area Network (WLAN) and Local Area Network (LAN). It can also operate as an AP (access point) client, which will bridge a connection from WLAN to LAN or vice versa. This Operation Mode page is the welcome screen for the SW550X Series. There are two operation modes to choose from:

- 1) **Wireless Client**
- 2) **AP Client.**

In **Wireless Client** mode, SW550X will have **two independent** network interfaces: LAN and WLAN. Each interface would have its own IP address; hence, traffic from the LAN interface won't be transferred to the WLAN interface, and vice versa.

In the **AP Client** mode, the LAN and the WLAN interfaces are **bridged together** to create one single bridged interface using one IP address. Traffic from either side of the network will be passed onto the other side of the network. The figure below shows the configuration page for **Operation Mode** of SW550X. The user can select one of the two radio buttons inside the Operation Mode box. An image on the right side of the box displays the SW550X as the blue circle while a remote access point (AP) that provides wireless access is the orange circle.

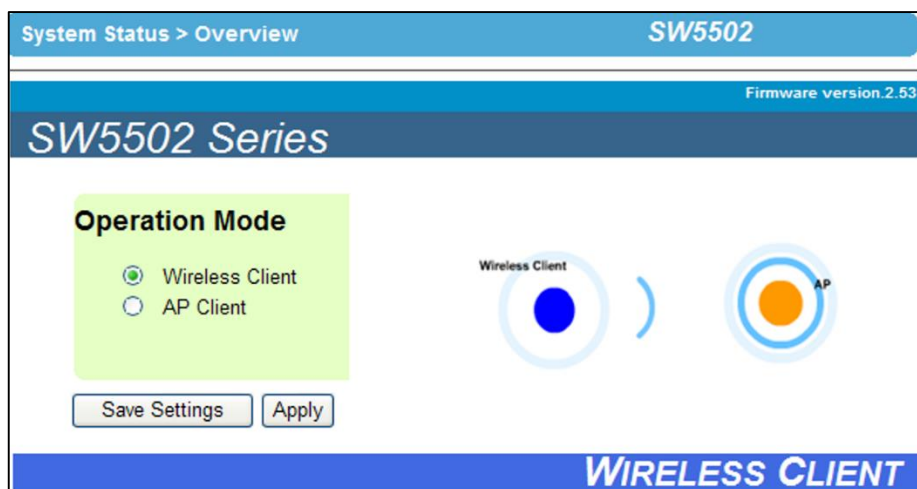

Figure 4.14 Configuration Page of Operation Mode with Wireless Client Setting

After finish configuring the **Operation Mode**, please click on **Save Settings** button to keep the change that you have made and to apply your setting. A pop-up window with a message “**Please wait for a while...**” will appear as shown below. When the saving is finished, the pop-up windows will disappear and return to the **Operation Mode** page.

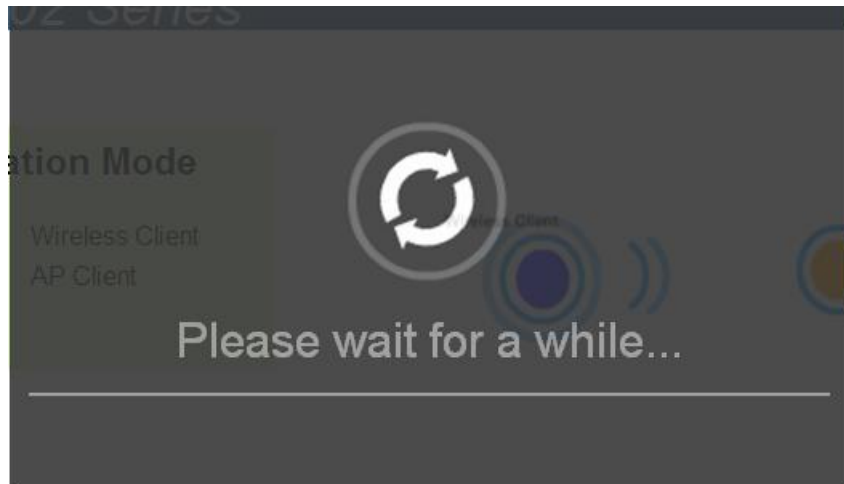

Figure 4.15 Waiting Message

If you only want to save the settings and restart the device to a selection of **Operation Mode**, you can click “**Apply**” button to apply the setting and reboot the SW550X device. Note that after clicking the “**Apply**” button, the user will briefly see the same pop-up window as in above and after a few second another pop-up window will appear as shown below. Then, you will be redirected back to the **Operation Mode** page.

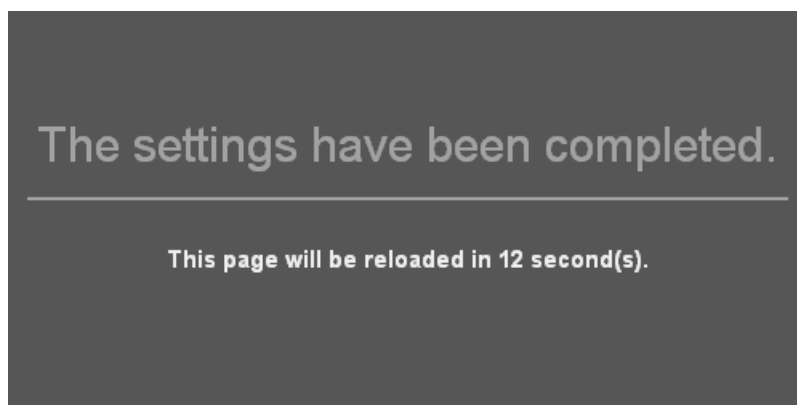

Figure 4.16 Completion of the settings and counting down for a page reload

The next figure shows an example of AP Client operation mode setting. Note that the graphic image on the right side of the box isplays the SW550X as the blue circle with an Ethernet connection to a device denoted with a green circle. The remote access point (AP) that provides wireless access is still represented by the orange circle.

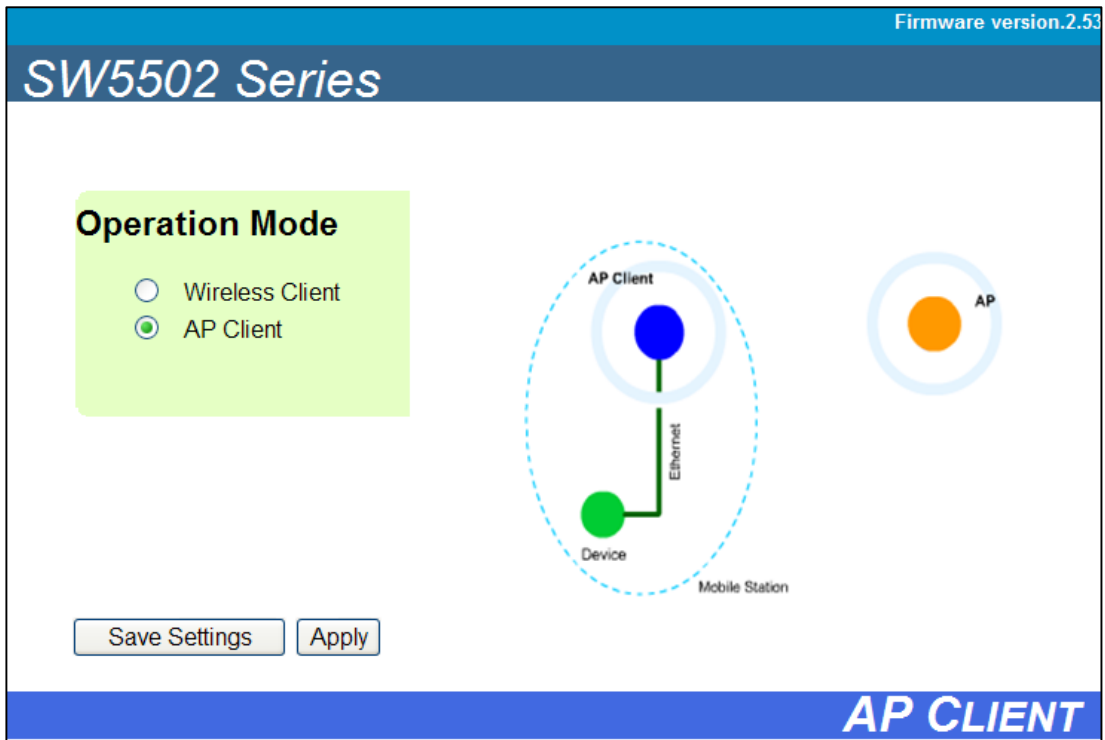

Figure 4.17 AP Client Operation Mode Setting

4.2.2 Overview

The “**Overview**” submenu under the “**System Status**” menu, displays overall and current general information on the SW550X device’s status and settings. An example of SW5502’s **Overview** page is shown below.

System Status > Overview
SW5502

**Overview**

The general device information of ATOP-Serial Server.

Device Information	
Model Name	SW5502
Device Name	0060E90DEEDC
Kernel Version	2.51
AP Version	2.53

Network Information		
LAN	MAC Address	00:60:e9:0d:ee:dc
	IP Address	10.0.50.100
WLAN	MAC Address	00:60:e9:0d:ee:dd
	Country code	US
	IP Address	192.168.1.1
	Status	CC:5D:4E:B3:5A:54 <div style="display: flex; align-items: center;"> <span style="width: 20px; height: 10px; background-color: green; margin-right: 5px;"></span> 92%                 </div>

COM 1 Information	
Serial Interface	RS-232
Link Mode	TCP Server
Baud Rate	9600
Parity	None
Data bits	8
Stop bits	1
Flow Control	None
Link Status	SERVER MODE: Listening[0]

COM 2 Information	
Serial Interface	RS-232
Link Mode	TCP Server
Baud Rate	9600
Parity	None
Data bits	8
Stop bits	1
Flow Control	None
Link Status	SERVER MODE: Listening[0]

Link Status: [N] is the session number connected.  
It's [0] when the link is connecting or listening.

Figure 4.18 Overview Information Page of an SW550X Device

- Information under the **Device Information** box displays the **Model Name**, the **Device Name**, **Kernel Version** and **AP Version** of the SW550X device. Note that the default **Device Name** is the **MAC address** of your device. The firmware version of your SW550X consists of the **Kernel Version** and the **AP Version**.
- Information under the **Network Information** box shows the summary of both **LAN** and **WLAN** interfaces. For **LAN** interface, there are its **MAC address** and current **IP address**. For **WLAN** interface, there are its **MAC Address**, the **Country code**, current **IP Address**, and the **Status** of the interface. Note that the Country code

indicates the available radio channels for your WLAN interface while the **Status** displays current MAC Address of an access point (AP) that the SW550X associates with and the AP's link quality in percent.

- Information under the **COM 1 Information & COM 2 Information** boxes report on the current serial connection setting of both interfaces which are the type of current **Serial Interface** (RS-232, RS-422, or RS-485), the **Link Mode**, the **Baud Rate**, the **Parity** bit, the **Data bits**, the **Stop bits**, the **Flow Control**, and the current **Link Status**. Note that the **Link Status** will show the mode of the port such as **SERVER MODE** and the number inside the square brackets ([N]) is the number of sessions that are connected in the corresponding COM port. If the number in the bracket is zero ([0]), it means that the port link is connecting or listening.

### 4.2.3 Wireless Status

The SW550X's current wireless network status is displayed in this section called "**Wireless Status**" submenu under the "**System Status**" menu. The current information is summarized below. Please remember to always keep a note of your preferred setting. The **Current Information** includes **SSID**, **BSSID (AP MAC)**, **Topology** (infrastructure or other), **Band mode**, **Channel**, **Encryption**, and **Status**. Note that the **Status** of current information will be display as green bar(s) with percentage number to indicate the quality of the wireless link.

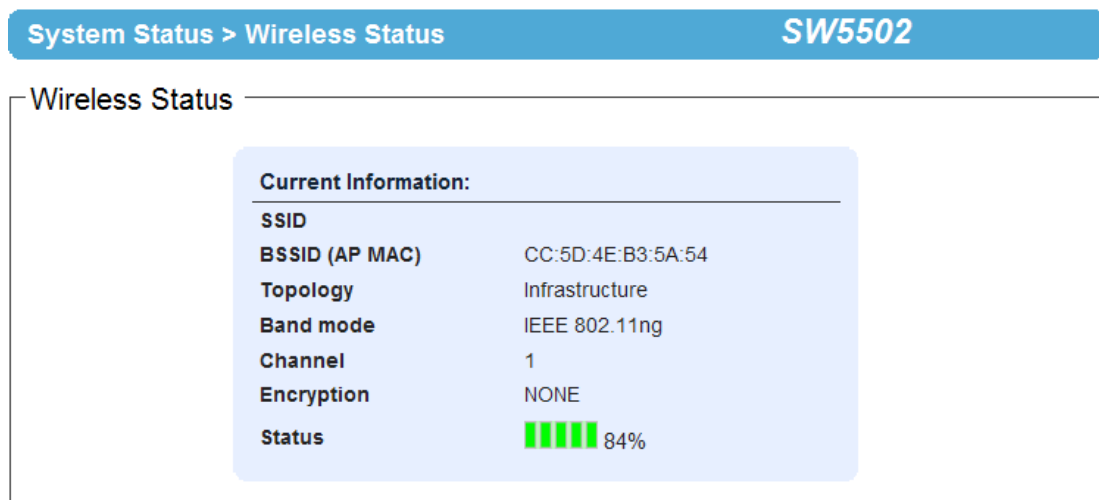

Figure 4.19 Wireless Status page shows current information of SW550X.

### 4.2.4 Site Monitor

**Site Monitor** submenu under the **System Status** menu allows users to view other wireless networks in the neighborhood. It also provides information on other access points (APs) such as **SSID**, occupied **Channel(s)**, the **RSSI (Received Signal Strength Indicator)**, Security and other parameters. It can be helpful when setting SSID and Channel number for your SW550X device to avoid SSID name and Channel number conflict and prevent unexpected errors or degradation of your wireless network performance. Note that it will take a few second (approximately 10 seconds) for this option to gather information of the surrounding wireless networks. During this process, the web page will show a "Please wait..." message with running animation as shown below.



Figure 4.20 Transition page during the gathering of surrounding wireless network information.

An example of a list of nearby WLAN APs which is reported by the **Site Monitor** is shown in Below figure. The available information include the **SSID**, the **Mode** of IEEE 802.11 standards (which could be 802.11a, 802.11b, 802.11g, 802.11n, or a combination of standards), the radio **Channel** number, the **Authentication** mode (such as Open, WPA-PSK, WPA2-PSK, WPA2(PEAP), WPA2(EAP-TLS), WPA2(EAP-TTLS)), the **Encryption** standards (such as None, WEP, AES or TKIP or a combination of TKIP/AES), the data rate in **Mbps**, and the quality of the wireless signal which is reported in **Signal%**.

The “**Refresh**” button at the bottom of the page allows user to obtain the latest information from the Site Monitoring process. Note that when there are two numbers under the **Channel** column, it means that there are **Primary Channel** and **Secondary Channel** used by that access points.

System Status > Site Monitor		SW5502					
Site Monitor							
SSID	Mode	Channel	Authentication	Encryption	Mbps	Signal%	
mokadi	b/g/n	1	WPA2-PSK	AES	300	100	
true_homewifi_e79b36	b/g	1	WPA-PSK	TKIP	54	39	
Sudasna_Wifi_Network	b/g/n	2	WPA-PSK	TKIP	14	19	
Larpsumphun's Home	b/g	6	OPEN	NONE	54	70	
Nostrada	b/g/n	6	WPA-PSK	AES	72	25	
rachata	b/g/n	11	WPA2-PSK	TKIP/AES	14	19	
SamRanNew	b/g	11	OPEN	NONE	54	11	
Samran	b/g/n	8	OPEN	NONE	130	28	
mokadi	b/g	36,40	WPA2-PSK	AES	450	100	
Supan	b/g	3	OPEN	WEP	54	28	
GiGZilla Wan	b/g/n	6,10	WPA2-PSK	AES	150	8	
DLINK_WIRELESS	b/g	6	OPEN	NONE	54	8	
Thugz Mansion	b/g/n	6,10	WPA2-PSK	AES	300	11	
TP-LINK	b/g	4	WPA-PSK	TKIP	54	8	

Channel is listed as Primary Channel, Secondary Channel

Figure 4.21 Results of a Site Monitoring of SW550X Series.



### 4.3 Web configuration - Network settings

The SW550X series have the ability to utilize dual connections, i.e., WLAN and LAN at the same time. The user can configure both LAN and WLAN interfaces in this section. An example of **Network Settings** page for SW550X in Wireless Client mode is shown below.

The screenshot shows the 'Network Settings' page for device 'SW5502'. The settings are as follows:

Gratuitous ARP	Disabled	5 minutes
<b>LAN interface</b>		
DHCP	<input type="checkbox"/> Obtain an IP Address Automatically	
IP Address	10.0.50.1	
Subnet Mask	255.255.0.0	
Default Gateway	10.0.0.254	
<b>Wireless LAN interface</b>		
DHCP	<input checked="" type="checkbox"/> Obtain an IP Address Automatically	
IP Address	169.253.136.137	
Subnet Mask	255.255.0.0	
Default Gateway	0.0.0.0	
<b>Default Gateway</b>		
Default Gateway Select	<input checked="" type="radio"/> WLAN <input type="radio"/> LAN	
<b>DNS Server</b>		
Preferred DNS		
Alternate DNS		

\* The IP subnets of Wireless and Wired interface must be in different subnets.

Buttons: Save & Apply, Cancel

Figure 4.22 Network Settings Page (Wireless Client Mode)

There are four configurable parts under **Network Settings** which are **LAN interface**, **Wireless LAN interface**, **Default Gateway** and **DNS Server**. The first configurable option under the Network Settings is Gratuitous ARP (Address Resolution Protocol). This option enables SW550X device to periodically send out an ARP response automatically to notify that SW550X device is in the network. The frequency of transmission is in minutes which can be selected from the pull-down menu and the period of transmission in the unit of minutes can be set in the followed textbox as shown.

#### 1) LAN Interface and Manual Settings Part

- a. SW550X device can get IP information automatically from a DHCP server in LAN. The user can check the box in front of the **"Obtain an IP Address Automatically"** to get the necessary IP information or enter the IP values manually if known in the **Manual Settings** section of this part.
- b. **Manual Settings** – If the user wants to fix the IP address of **LAN interface**, the desired **IP Address**, **Subnet Mask**, and **Default Gateway** should be entered in this section.

2) **Wireless LAN Interface Part**

- a. SW550X device can also get IP information automatically from a DHCP server in WLAN as well. The user can check the box in front of the **“Obtain an IP Address Automatically”** to get the IP information or enter the IP values manually if known in the following fields of this part.
- b. IP Settings for WLAN also include the desired **IP Address, Subnet Mask, and Default Gateway.**

Note that under the **Wireless Client** mode, LAN and WLAN can be seen separately. They need to be configured into different subnets. The user must choose which interface that should be the **Default Gateway** by selecting the corresponding radio buttons between **WLAN** and **LAN** as shown in the screenshot (see next part).

3) **Default Gateway Part**

**Default Gateway Selection** specifies either **WLAN** or **LAN** interface as the default gateway. The selected interface is usually the one that is connected to a network gateway or Internet. Settings from one of them will not be applicable to the other, i.e., if the WLAN is selected over the LAN then IP, Subnet mask, etc., on the LAN side will be OFF. However, it can be changed to another value not in used and save those parameters.

Note that under the **AP Client** mode, you will only see one bridged interface (**LAN & WLAN Interface**) and the default gateway selection will be unnecessary (this part will disappear) as shown below.

Network Settings
SW5502

Network Settings

Gratuitous ARP (LAN only)	Disabled ▾	5	minutes
<b>LAN &amp; WLAN interfaces</b>			
DHCP	<input type="checkbox"/> Obtain an IP Address Automatically		
IP Address	<input type="text" value="10.0.50.1"/>		
Subnet Mask	<input type="text" value="255.255.0.0"/>		
Default Gateway	<input type="text" value="10.0.0.254"/>		
<b>DNS Server</b>			
Preferred DNS	<input type="text"/>		
Alternate DNS	<input type="text"/>		

\* The IP subnets of Wireless and Wired interface must be in different subnets.

Figure 4.23 Network Settings Page for Bridged Interface (AP Client Mode)

- 4) DNS Server Part:  
To allow your SW550X device to properly connect to the Internet and be able to resolve for a host over the Internet, you must specify Preferred DNS (Domain Name Server) and (optionally) Alternate DNS in this part.

After finish configuring the **Network Settings**, please click on **Save & Apply** button to keep the change that you have made and to apply your setting. A pop-up window with a message **"Please wait for a while..."** will appear briefly. Then, another pop-up window with message **"The settings have been completed"** will be displayed. When the saving and applying are finished, the pop-up window will disappear and the web browser will be redirected to the **Operation Mode** page. If you want to cancel the change and reset all changes back to their original values, just click the **Cancel** button.

---

## 4.4 Web configuration – Wireless Settings

---

### 4.4.1 Wireless Profiles

Starting from firmware version V3.XX, each wireless profile can be directly set from the profile webpage. Users no longer need to set wireless profile through the Basic Setting (see next subsection). When the **Wireless Profile** is enabled by checking the **Enabled** box and clicking **Apply** button behind the **Wireless Profile** option, there will be an **Add** button under the **AP List** for adding new wireless profile as shown below.

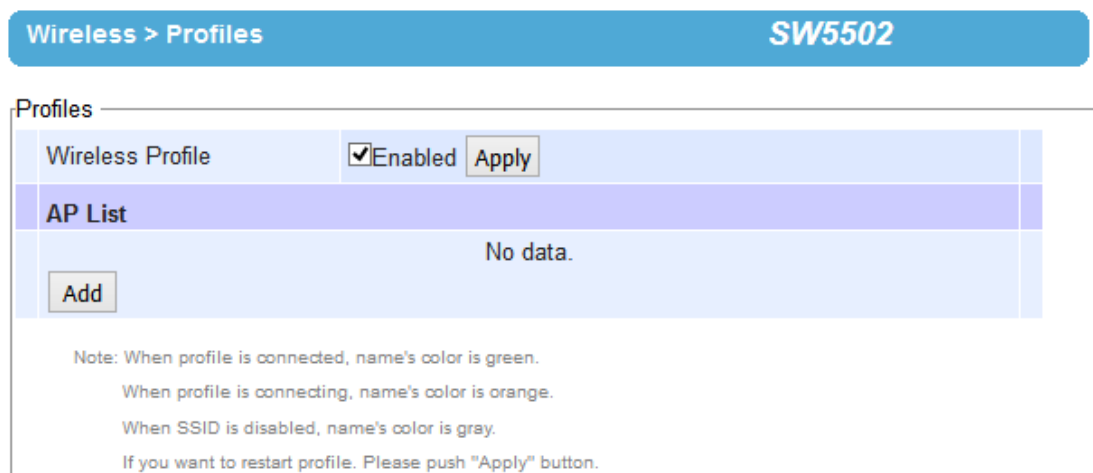

**Figure 4.24 Enabling Wireless Profile Option to Add New Access Point**

This will bring up the **Basic Settings List** webpage as shown in in the next page for entering the necessary information of each wireless profile. Description of each field can be found in the next subsection. When entering all necessary information of the wireless profile, click **Save** button at the bottom. Users are allowed to save up to ten wireless connection profiles or list of network names or SSIDs (called **AP List**) inside SW550X. SW550X will retry each and every enabled profile (network name or SSID) for one minute before continuing to the next profile if the current profile failed to connect.

You can use the **Sort** column to adjust the precedence of the profiles. However, this function is disabled by default.

Wireless > Profiles
SW5502

Basic Settings List

Enable	<input type="checkbox"/>	
SSID	<input type="text"/>	<input type="button" value="scan network"/>
BSSID(MAC Address)	<input type="text" value="(Any)"/>	<input type="checkbox"/> Enabled
Topology	Infrastructure ▾	
Band mode	Auto ▾	<input checked="" type="checkbox"/> Auto
BandWidth	Auto 20/40 MHz ▾	
Channel	Auto ▾	
Authentication Mode	OPEN ▾	
Encryption Type	NONE ▾	
<b>WEP Key</b>		
	<input checked="" type="radio"/> Key 1: HEX (10 or 26 digits) ▾	<input type="text" value="0123456789"/>
	<input type="radio"/> Key 2: HEX (10 or 26 digits) ▾	<input type="text" value="0123456788"/>
	<input type="radio"/> Key 3: HEX (10 or 26 digits) ▾	<input type="text" value="0123456787"/>
	<input type="radio"/> Key 4: HEX (10 or 26 digits) ▾	<input type="text" value="0123456786"/>
<b>WPA-P SK/WPA2-P SK</b>		
Passphrase	<input type="text" value="•"/>	<input checked="" type="checkbox"/> Hide
<b>WPA2(with Radius)</b>		
User	<input type="text" value="wpa_user"/>	
Password	<input type="text" value="••••••••"/>	
Certificates	<input type="button" value="Browse..."/> No file selected.	
	<input type="button" value="Upload CA certificate"/> <input type="button" value="Upload Client certificate"/>	
	<input type="button" value="Show Certificates Information"/>	
Private key password	<input type="text" value="••••••••"/>	

Figure 4.25 Basic Setting List Webpage after Clicking Add Button

Figure below shows an example of enabled Wireless Profile in which an **AP List** consists of ten available entries for network names or SSIDs. Each entry will have its number (**No.**) on the list and **Name**. Color of the **Name** is used to indicate the current status of the SSID or profile on the list. When the color of the **Name** is green, the profile is connected. When the color of the **Name** is orange, the profile is connecting. When the color of the **Name** is grey, the profile is disabled. Under the **Modify** column, there are two options: **Edit** and **Delete**. If the user clicks on **Edit**, this will bring up the **Basic Setting List** webpage. On the other hand, if the user clicks on **Delete**, this will remove the profile from the list. The last column in the list is the **Sort** column which has arrow button(s) to allow changing the order of the profiles (access points) on the list.

Wireless > Profiles SW5502

Profiles

Wireless Profile  Enabled

AP List

No.	Name	Modify	Sort
1		<a href="#">Edit</a> <a href="#">Delete</a>	<input type="button" value="↑"/> <input type="button" value="↓"/>
2		<a href="#">Edit</a> <a href="#">Delete</a>	<input type="button" value="↑"/> <input type="button" value="↓"/>
3		<a href="#">Edit</a> <a href="#">Delete</a>	<input type="button" value="↑"/> <input type="button" value="↓"/>
4		<a href="#">Edit</a> <a href="#">Delete</a>	<input type="button" value="↑"/> <input type="button" value="↓"/>
5		<a href="#">Edit</a> <a href="#">Delete</a>	<input type="button" value="↑"/> <input type="button" value="↓"/>
6		<a href="#">Edit</a> <a href="#">Delete</a>	<input type="button" value="↑"/> <input type="button" value="↓"/>
7		<a href="#">Edit</a> <a href="#">Delete</a>	<input type="button" value="↑"/> <input type="button" value="↓"/>
8		<a href="#">Edit</a> <a href="#">Delete</a>	<input type="button" value="↑"/> <input type="button" value="↓"/>
9		<a href="#">Edit</a> <a href="#">Delete</a>	<input type="button" value="↑"/> <input type="button" value="↓"/>
10		<a href="#">Edit</a> <a href="#">Delete</a>	<input type="button" value="↑"/> <input type="button" value="↓"/>

Note: When profile is connected, name's color is green.  
When profile is connecting, name's color is orange.  
When SSID is disabled, name's color is gray.  
If you want restart profile. Please push "Apply" button.

Figure 4.26 Wireless Profile Page

#### 4.4.2 Basic Settings

To set up a wireless connection for SW550X, a number of parameters are needed to be configured in this section. However, the user will have two different wireless configuring pages when **Wireless Profile** (see previous subsection) is enabled as shown in previous paragraph and when **Wireless Profile** is disabled as shown in Figure below. The only differences between the two pages are that when **Wireless Profile** is enabled, the **Basic Settings** webpage will be disabled or cannot be used. When **Wireless Profile** option is enabled by checking the **Enabled** box (see previous paragraph), the following sentence will be displayed in the pop-up window: "Basic Settings can't be used, because Profile is enabled" as shown in figure below.

When **Wireless Profile** is disabled, the **Basic Settings** webpage can be used. The default settings in **Basic Settings** page can be in two **Topology** modes: **Infrastructure Mode** or **Ad Hoc Mode**. The user will have both modes to choose from. **Table 4.2** and **Table 4.3** summarized the default settings for **Infrastructure mode** and **Ad Hoc mode**, respectively.

**Table 4.2 Default Settings in Infrastructure Mode:**

Caption	Default
SSID	Null
BSSID (MAC Address)	Any (unless enabled)
Topology	Infrastructure
Band Mode	Automatic Detection
Channel	Automatic Detection
Bandwidth <sup>1</sup>	Automatic Detection
Secondary Channel	Automatic Detection
Authentication Mode	OPEN
Encryption Type	NONE

Table 4.3 Default Settings in Ad Hoc Mode:

Caption	Default
Radio Off	Disabled (box not checked)
SSID	Null
BSSID (MAC Address)	Any (unless enabled)
Topology	Ad-Hoc
Band Mode	802.11a
Channel	36
Bandwidth <sup>1</sup>	20 MHz
Secondary Channel	Disabled
Authentication Mode	OPEN
Encryption Type	NONE



**Figure 4.27 Basic Settings for Wireless Connection when Wireless Profile is Enabled**

Wireless > Basic Settings
SW5502

---

Basic Settings

SSID	<input type="text"/>	<input type="button" value="scan network"/>
BSSID(MAC Address)	<input type="text" value="(Any)"/>	<input type="checkbox"/> Enabled
WPS BUTTON	<input type="button" value="Start WPS PBC"/>	
Topology	Infrastructure ▼	
Band mode	802.11b/g ▼	<input checked="" type="checkbox"/> Auto
BandWidth	Auto 20/40 MHz ▼	
Channel	Auto ▼	
Authentication Mode	WPA2-PSK ▼	
Encryption Type	AES ▼	
<b>WEP Key</b>		
	<input checked="" type="radio"/> Key 1: ASCII (5 or 13 characters) ▼ <input type="radio"/> Key 2: HEX (10 or 26 digits) ▼ <input type="radio"/> Key 3: HEX (10 or 26 digits) ▼ <input type="radio"/> Key 4: HEX (10 or 26 digits) ▼	<input type="text"/> <input type="text"/> <input type="text"/> <input type="text"/>
<b>WPA-PSK/WPA2-PSK</b>		
Passphrase	<input type="text" value="....."/>	<input checked="" type="checkbox"/> Hide
<b>WPA2(with Radius)</b>		
User	<input type="text" value="wpa_user"/>	
Password	<input type="text" value="....."/>	
Certificates	<input type="button" value="เลือกไฟล์"/> <input type="button" value="ไม่ได้เลือกไฟล์ใด"/> <input type="button" value="Upload CA certificate"/> <input type="button" value="Upload Client certificate"/> <input type="button" value="Show Certificates Informator"/>	
Private key password	<input type="text" value="....."/>	

In Ad-Hoc mode, Device will change its settings to adapt to other, if there are same SSID nearby.

Figure 4.28 Basic Settings for Wireless Connection when Wireless Profile is Disabled.

After the user finished setting the **Basic Settings** as shown above, please click the **Save & Apply** button to save the new wireless configuration on the SW550X and allow the configuration to take effect. If the user want to discard any changes on the configuration, please click **Cancel** button. Then, the page will be reloaded.



### Attention

- In order to avoid disconnection issue, using LAN interface to setup Wireless Configurations is recommended. The Web UI (User Interface) might freeze or lock up if the setup is made using the wireless interface because the connection would be lost whenever wireless settings are changed. It might take some time for the device to attach to the Access Point with new settings.

Each configurable option under the **Basic Settings** is described as follows:

- **SSID:** This specifies the SSID (or network name) that SW550X should connect to wirelessly. There is a “**Scan Network**” button on the right of the empty text box. This button makes it possible to look for nearby available wireless networks to attach to. Once clicked, it will start a scanning process and prompt a window with a list of available wireless networks. Detailed steps for setting the **SSID** or using **Scan Network** button will be explained after this list.
- **BSSID (MAC Address):** This refers to access point’s MAC address on which the SW550X should connect to. Enabling this option by checking the box behind it will lock SW550X to that access point. Therefore, SW550X would not roam to another access point with the same SSID.
- **WPS BUTTON:** The **WPS** acronym stands for **Wi-Fi Protected Setup** and the **PBC** stands for **Push Button Configuration**. To use this feature, first trigger the WPS process in a WPS supported access point (AP) and click on the **Start WPS PBC** button on SW550X’s UI. The AP and the SW550X should connect automatically. Note that the **Topology** setting (next option) in this case should be **Infrastructure** and the **Band Mode** (option after the next) should be **Auto** so that the **WPS** can work. Note that this button is unavailable when the **Wireless Profiles** is enabled.
- **Topology:** There are two type of wireless network topologies which are **Infrastructure** (for connecting to an Access Point) or **Ad Hoc** (for connecting to a wireless client). Note that the **Ad Hoc** mode is unavailable when the **Wireless Profiles** is enabled.
- **Band Mode:** This option allows user to select the radio frequency band which are supported by IEEE 802.11b, 802.11b/g, 802.11b/g/n, 802.11a, and 802.11a/n standards. It is recommended to leave this option to **Auto** for SW550X to sense for the best available mode automatically by checking the **Auto** box.
- **Channel:** This option allows the user to specify the radio channel number for SW550X to operate on. However, the available channels would depend on the **Band Mode** and the regulatory domain (CN, EU, TW, or US) selected in the **Wireless Advanced Settings** (discussed next section). This option is disabled when the **Band Mode** is set to **Auto**.
- **Bandwidth:** This option allows SW550X to select between 20 MHz or 40 MHz radio bandwidth usage. The latter fills a larger spectrum; hence, it provides a better throughput if it is allowed by the Access Point. However, it is not recommended to use 40 MHz at 2.4 GHz band for IEEE 802.11b/g/n standards.
- **Channel:** This option specifies the radio channel number that SW550X will use which can be chosen from the drop down list between 1 and 11.
- **Authentication Mode:** This option allows the selection of wireless network authentication mechanisms which could be **OPEN, SHARED, WPA-PSK, WPA2-PSK, WPA2 (PEAP), WPA2 (EAP-TLS), and WPA2 (EAP-TTLS)**.
- **Encryption Type:** This option specifies the encryption algorithm for wireless connection which could be **WEP, TKIP** and **AES**. However, please beware that **WEP** and **TKIP** are not supported by the IEEE 802.11n standard; therefore, the wireless link speed would be limited to 54Mbps.
- **WEP Key:** This option is enabled when **Authentication Mode** is set to **OPEN** and **Encryption Type** is set to **WEP**. Up to 4 different hexadecimal or ASCII keys can be entered in this option.
- **WPA-PSK/WPA2-PSK Passphrase:** This option is enabled when **Authentication Mode** is set to **WPA-PSK** or **WPA2-PSK**. The passphrase can be between 8 and 63 characters long.
- **WPA2 (with RADIUS):** Depending on selected **Authentication Mode**, different fields in this option will be enabled. **WPA2 (PEAP)** would require you to provide the user, password, and the certificates. **WPA2 (EAP-**



**TLS**) would require you to provide the certificates and private key password. **WPA2 (EAP-TLS)** would require you to provide the user, the password, and the certificates. Please note that only \*.pem certificates are supported.

Please remember that 2.4 GHz frequency can be easily interfered by other wireless devices that operate in the same spectrum (namely, Bluetooth, ZigBee, microwave oven, etc.); therefore, it is better to choose the IEEE 802.11a/n which operates in the 5 GHz spectrum when the user’s network allows.

**Steps to Connect to an Access Point**

You can manually enter the **SSID** of the connecting access point in the **SSID** option or use the “**scan network**” button to have SW550X grab the necessary wireless information of surrounding access points in the device’s coverage area. Please be patient as this process might take up to 10 seconds.

Once it has finished scanning, names and basic properties of available wireless networks will be shown below. You can then select an AP from the list by clicking on the radio button in front of the desired SSID. Then, click on the “**Connect**” button at the bottom of the page and its settings would be loaded automatically to the device’s user interface (UI). If you would like the scanning process to run again, just click on the “**Refresh**” button. Otherwise, click on the “**Close**” button to close this window.

SSID	MAC Address	T	Mode	Channel	Authentication	Encryption	*Mbps	Signal%
<input type="radio"/> ATOP-S-Link	00:60:E9:	Infra	b/g/n	1	WPA2-PSK	AES	144	45
<input type="radio"/> SW5502-Sis-Test-1	F4:4E:B7	Adhoc	b	1	OPEN	NONE	11	15
<input type="radio"/> AWAWAWAWAW	00:60:E9	Infra	b/g/n	11	OPEN	NONE	300	45
<input type="radio"/> banmu02	00:14:93	Infra	b/g	11	WPA2-PSK	TKIP	54	11
<input type="radio"/> Gay_Test	00:60:E9	Infra	b/g/n	1,5	WPA2-PSK	AES	300	3

●

T is Topology (Infra = Infrastructure, Adhoc)  
Channel is listed as Primary Channel, Secondary Channel

Figure 4.29 Results of network scanning when uses “scan network” buttons

If no wireless networks have been found, the list would be empty as shown below.

SSID	MAC Address	T	Mode	Channel	Authentication	Encryption	Mbps	Signal%
There is no wireless network detected.								

T is Topology (Infra = Infrastructure, Adhoc)  
Channel is listed as Primary Channel, Secondary Channel

Figure 4.30 Result when there is no wireless network available in the area.

After finish configuring the **Basic Settings**, please click on **Save** button to keep the change that you have made. A pop-up window with message “**Please wait for a while...**” will be displayed. When the saving is finished, the pop-up window will disappear and the web browser will remain on the **Basic Settings** page. If you want to cancel the change and reset all changes back to their original values, just click the **Cancel** button.

#### 4.4.3 Advanced Settings

This subsection provides details on wireless network parameters for performance tuning. Changing options in this section may affect overall performance of your SW550X; therefore, please be cautious. If you are still unclear on the effect of each option, please refrain from altering it. Figure below depicts the **Wireless Advanced Settings** page.

The screenshot shows the 'Wireless > Advanced Settings' page for device 'SW5502-TB'. The settings are as follows:

Radio Off	<input type="checkbox"/> Enabled
Fast Handoff	<input type="checkbox"/> Enabled
Fast Roaming	<input type="checkbox"/> Enabled
Roaming Threshold	<input type="radio"/> Low (25%) <input type="radio"/> Normal (50%) <input type="radio"/> High (75%)
Tx Power	100 %
*Regulatory Domain	[Dropdown]
*Disconnected Detection	<input type="checkbox"/> Enabled
Time	30 seconds (30-300)
Target IP	[Text Input]

Below the table, there is a note: "Different regulatory domains will result in different channels/frequencies being allowed. Device will reconnect with AP when detecting wireless disconnected after 'Time' seconds." At the bottom, there are 'Save & Apply' and 'Cancel' buttons.

Figure 4.31 Wireless Advanced Settings Page when Wireless Profile is Disabled and Topology is set to infrastructure

- **Radio Off** – When this option is enabled, this allows the user to turn off the wireless interface completely.
- **Fast Handoff** – This option enables Atop’s proprietary protocol to speed up roaming between AW5500s (Atop’s Industrial Wireless Serial Device Servers) in addition to Fast Roaming (next option). Enable this option to allow AW5500 to share its neighboring AW5500 information to SW550X to further reduce its roaming time.
- **Fast Roaming** – Enable this option to allow SW550X to scan for available access points in the background to speed up roaming when necessary.
- **Roaming Threshold** – This option set the threshold level used to determine when SW550X should try to connect to another access point when the wireless signal drops below the selected range. The available thresholds are Low (25%), Normal (50%), and High (75%).
- **Tx Power** – This option allows user to set the SW550X’s **Transmission Power**. The transmission power can be reduced to prevent wireless interference to other wireless networks.
- **Regulatory Domain** – This can be selected from 4 options in the drop-down list box: CN(APL1\_WORLD), EU(ETSI2\_WORLD), TW(APL3\_FCCA), US(FCC5\_FCCA), and VN(ETSI3\_WORLD). Note that different

Regulatory Domains will result in different radio channels/frequencies being allowed SW550X to operate (see **Channel** setting in previous subsection).

- **Disconnected Detection** – When this option is checked, SW550X will use the **Ping** command to check whether the wireless connection between SW550X and a target device is still active. When the **Disconnected Detection** is already enabled and the mentioned connection is disconnected, SW550X will re-initiate wireless connection again after a certain period of time which can be set in the **Time** option (next line). The reconnection time can be set between 30 and 300 seconds. The target device can be specified by entering its IP address in the **Target IP** option. Note that the user should ensure that SW550X can establish the connection with its target device first.
- **STP** – The **Spanning Tree Protocol** is only available in the **AP Client** mode. Enable this option if STP is enabled in the user’s network to prevent network loops by setting up the **Forward Delay** time. When disabled, SW550X will not forward STP Bridge Protocol Data Units (BPDUs).

Note that if Wireless Profile (Paragraph 4.4.1 above) feature is enabled, Fast Handoff, Fast Roaming and Roaming Threshold, and STP options will not be presented and supported, as shown below.

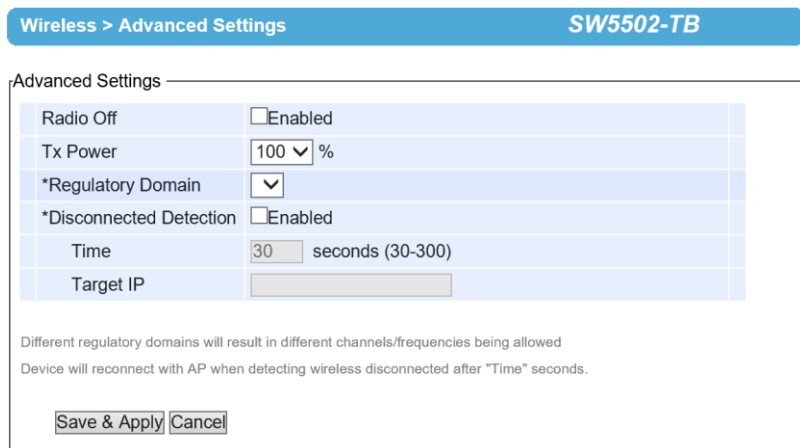

Figure 4.32 Wireless Advanced Settings Page when Wireless Profile is Enabled

After finish configuring the **Advanced Settings**, please click on **“Save & Apply”** button to keep the change that you have made. A pop-up window with a message **“Please wait for a while...”** will appear briefly. Then, another pop-up window with message **“The settings have been completed”** will be displayed. When the saving and applying are finished, the pop-up window will disappear and the web browser will be redirected to the **Operation Mode** page. If you want to cancel the change and reset all changes back to their original values, just click the **Cancel** button.

## 4.5 Web configuration – Serial

### 4.5.1 COM Port Overview

Since details on **Link Mode** connectivity protocols and its settings of SW550X series are given in the [Chapter \*\*Error! Reference source not found.\*\*](#) Chapter, this section will only focus on the **Serial Settings** only. Figure below shows an example of the COM 1 Port Settings where the upper part is dedicated for **Link Mode** settings and the lower part is dedicated for **Serial Settings**. Note that similar settings page is applicable for COM 2 Port Settings on SW550X device.

Serial > COM1
SW5502

COM 1 Port Settings

**LINK Mode**  
To choose specific working mode for COM 1 port.

TCP Server
  TCP Client
  UDP

TCP Server	
Application	R&W
IP Filter	<input type="checkbox"/> Enable
Source IP	0 . 0 . 0 . 0
Local Port	4660
Maximum Connection	1
Response Behavior	<input type="radio"/> Request & Response Mode <input type="radio"/> Reply to requester only <input checked="" type="radio"/> Reply to all <input checked="" type="radio"/> Transparent Mode

To configure COM 1 port parameters.

Serial Settings	
Serial Interface	<input checked="" type="radio"/> RS232 <input type="radio"/> RS422 <input type="radio"/> RS485(2-Wire) <input type="radio"/> RS485(4-Wire)
Baud Rate	9600 bps
Parity	<input checked="" type="radio"/> None <input type="radio"/> Odd <input type="radio"/> Even <input type="radio"/> Mark <input type="radio"/> Space
Data bits	<input type="radio"/> 5 bits <input type="radio"/> 6 bits <input type="radio"/> 7 bits <input checked="" type="radio"/> 8 bits
Stop bits	<input checked="" type="radio"/> 1 bit <input type="radio"/> 2 bits
Flow Control	<input checked="" type="radio"/> None <input type="radio"/> Xon/Xoff <input type="radio"/> RTS/CTS

Figure 4.33 COM 1 Port Setting Page

#### 4.5.2 COM Configuration

Figure below shows the **Serial Settings** part of **COM** port settings. Note that these settings need to match the parameters on serial port of the serial device. Each option is later on described in detail.

Serial Settings	
Serial Interface	<input checked="" type="radio"/> RS232 <input type="radio"/> RS422 <input type="radio"/> RS485(2-Wire) <input type="radio"/> RS485(4-Wire)
Baud Rate	9600 <input type="text"/> bps
Parity	<input checked="" type="radio"/> None <input type="radio"/> Odd <input type="radio"/> Even <input type="radio"/> Mark <input type="radio"/> Space
Data bits	<input type="radio"/> 5 bits <input type="radio"/> 6 bits <input type="radio"/> 7 bits <input checked="" type="radio"/> 8 bits
Stop bits	<input checked="" type="radio"/> 1 bit <input type="radio"/> 2 bits
Flow Control	<input checked="" type="radio"/> None <input type="radio"/> Xon/Xoff <input type="radio"/> RTS/CTS

Figure 4.34 Serial Settings Part of COM Port

- **Serial Interface:** This option allows selection between RS-232, RS-422, and RS-485 standards. Note that RS-485 support both 2-Wire RS-485 and 4-Wire RS-485.
- **Baud Rate:** The user can select one of the baud rates (from 110 to 921600 bps) from the drop-down list.
- **Parity:** The available **Parity** options are None, Odd, Even, Mark, or Space.
- **Data Bits:** The setting for **Data Bits** can be 5 bits, 6 bits, 7 bits, or 8 bits.
- **Stop Bits:** The number of **Stop Bits** can be either 1 bit or 2 bits.
- **Flow Control:** The user can choose among None (No Flow Control), RTS/CTS (Hardware Flow Control), or Xon/Xoff (Software Flow Control). If Xon/Xoff is selected, the Xon and Xoff characters are changeable. Defaults are 0x11 for Xon and 0x13 for Xoff. Note that these are hexadecimal number of ASCII characters (i.e., 0x11 = '1' and 0x13 = '3'). If the connecting program or serial device would like to receive the Xon/Xoff signals also, the user can enable the **"Permit Xon/Xoff Character Pass Through"** by checking the box in front of the option.

After finish configuring the COM Port **Serial Settings**, click on **Save & Apply** button to keep the change that you have made. Note that after click Save & Apply the web browser will remain on the **Serial Settings** page. If you want to cancel the change and reset all changes back to their original values, just click the **Cancel** button. The Advanced Settings button will be described in the next subsection.

### 4.5.3 COM Configuration: Advanced Settings

For advanced details of COM port setting, click on **Advanced Settings** button at the end of **Serial Settings** page. It will open another web browser window as shown below. Description of each option is explained as follows.

COM 1 Advance Settings

ADVANCED SETTINGS		
<b>TCP</b>	APP-level Receive Timeout	<input checked="" type="checkbox"/> Enable <input type="text" value="3600"/> (0~36000) seconds
	TCP Timeout	<input type="checkbox"/> Enable <input type="text" value="60"/> (6~36000) seconds
	Wait Time to Reconnect	<input type="text" value="3"/> (1~100) seconds
	Check Medium	<input type="checkbox"/> Close socket after medium is down for <input type="text" value="0"/> (3~30) seconds.
<b>Delimiters</b>	Serial to Network Packet Delimiter	<input checked="" type="checkbox"/> Interval timeout <input type="text" value="2"/> (1~30000) ms <input checked="" type="radio"/> Auto(caculate by baudrate) <input type="radio"/> Manual setting <input checked="" type="checkbox"/> Discard Bytes <input type="text" value="65535"/> within the time interval(1~1024)bytes <input type="checkbox"/> Max. Bytes <input type="text" value="1452"/> (within one packet:1~1452 bytes) <input type="checkbox"/> Character <input type="text" value="0x0d0a"/> ("0x"+ASCII Code, Ex. 0x0d or 0x0d0a)
	Network to Serial Packet Delimiter	<input type="checkbox"/> Interval timeout <input type="text" value="10"/> (1~30000) ms <input type="checkbox"/> Max. Bytes <input type="text" value="1452"/> (within one packet:1~1452 bytes) <input type="checkbox"/> Character <input type="text" value="0x0d0a"/> ("0x"+ASCII Code, Ex. 0x0d or 0x0d0a) <input type="checkbox"/> Send one character every <input type="text" value="0"/> (0~1000) ms
<b>Request &amp; Response</b>	Response Interval Timeout	<input checked="" type="checkbox"/> Enable <input type="text" value="1000"/> (0~60000) ms (Work with Request & Response Mode only)
<b>Serial</b>	Serial FIFO	<input checked="" type="checkbox"/> Enable (Disabling this option at baud rates higher than 115200bps would result in data loss).
	Serial Buffer	<input checked="" type="checkbox"/> Empty serial buffer when a new TCP connection is established

Figure 4.35 Advanced COM Port Settings Page

## TCP

- **APP-level Receive Timeout:** This option specifies the value of Application Level Timeout to force SW550X to actively close a TCP connection if SW550X did not receive packet from application layer for some specific inactivity period (i.e. no exchanged packets). The default value is 3,600 seconds. The maximum value is 36,000 seconds. Disabling this option means that SW550X would never actively close an established connection.
- **TCP timeout:** By clicking the **Enable** box of **TCP Timeout** and input value in seconds between 6 an 36000, the TCP-socket keep-alive feature in SW550X will be enabled. After the timer expires, the TCP's keep-alive procedure will send a keep-alive packet to its peer to check wether the connection is broken.
- **Wait time to reconnect:** The user can only use this feature when SW550X is on TCP client mode. After a TCP connection is closed, the device will wait for a specific interval of time before it creates a new socket. The time interval can be set between 1 and 100 seconds.

- **Check Medium:** Due to the unstable nature of wireless connections, sometimes even the connection (physical layer) is already broken, the TCP Server (application layer) is unaware and still active. Some applications establish a new TCP connection instead of recycling an old connection, the existing TCP connection needs to be automatically closed to allow a new incoming TCP Client connection. With this option, the user can set the waiting time of the physical medium's recovery. The period of waiting time can be in between 3 to 30 seconds. If the physical connection cannot be recovered in the previously set time, the TCP Server will forcefully close the existing TCP connection. The default value is three seconds. Decreasing this value might result in unfavorable network behavior.

## Delimiters

- **Serial to Network Packet Delimiter:** Packet delimiter is a way of packing data in the serial communication. It is designed to keep packets in track. SW550X provides three types of delimiter: Time Delimiter, Maximum Bytes and Character Delimiter. Note that the following delimiters (Interval, Max Byte and Character) when they are selected are programmed in the OR logic. Meaning that if any of the three conditions were met, SW550X would transmit the serial data in its buffer over the network.
- **Interval timeout:** SW550X will transmit the serial data in its buffer when the specified time interval has reached and no more serial data comes in. The default value is calculated automatically based on the baud rate. If the automatic value results in chopped data, the timeout could be increased manually by switching to "Manual setting" (checking the radio button in Figure 3.35) and specifying a larger value in the text box above. Note that the maximum interval is 60,000 milliseconds.

**Attention**  
**Manual Calculation of Interval Timeout**



The optimal "Interval timeout" depends on the application but it must be at least larger than one character interval within the specified baud rate. For example, assuming that the serial port is set to 1200 bps, 8 data bits, 1 stop bit, and no parity. In this case, the total number of bits needed to send a character is 10 bits (included 1 start bit), and the time required to transfer one character is  $(10 \text{ (bits)}/1200 \text{ (bits/s)}) * 1000 \text{ (ms/s)} = 8.3 \text{ ms}$ . Therefore, you should set the "Interval timeout" to be larger than 8.3 ms. Rounding 8.3 ms to the next integer would give you 9 ms. Which can be set as your interval timeout.

- **Discard Bytes:** SW550X will keep packets from the serial interface into its buffer, assemble data into a TCP packet based on user's setup condition, and then send the packet to the network. The compared condition to discard data can be more than, less than, equal to, or non-equal to a specific number of data (in Bytes). Within the timeout interval, if the condition is not satisfied, the data in buffer will be packed and sent out.
- **Max Bytes:** SW550X will transmit the serial data in its buffer when the specified length in the unit of bytes has reached. The range of maximum bytes is between 1 to 1452 bytes. Enable this option if you would like SW550X to queue the data until it reaches a specific length. This option is disabled by default.

- **Character:** SW550X will transmit the serial data in its buffer when it sees the incoming data include the specified character (in hexadecimal (HEX) format). This field allows one or two characters. If character delimiter is set to 0x0d, SW550X will push out its serial buffer when it sees 0x0d (carriage return) in the serial data. This option is disabled by default.
- **Send one character every  ms:** SW550X will save packets received from the network to its buffer, while keep sending one character every designate time interval.
- **Network to Serial Packet Delimiter:** This group of options is the same as the delimiters described above, but they control data flow in the opposite direction. SW550X will store data from the network interface in its queue. Until one of the delimiter conditions described above is met then SW550X will send the data over to the serial interface.
- **Character Send Interval:** This option specifies the time gap between each character. When set to one second (1000ms), SW550X would split the data in the queue and only transmit one character (a byte) every 1 second. The maximum value for this option is 1000 milliseconds or 1 second. This option is disabled by default.
- **Response Interval Timeout:** This option only affects the Request & Response Mode and has no effect on the Transparent Mode. Please see the discussion about Request & Respond Mode versus Transparent Mode later. When TCP data is received (a request from network) and passed to serial device side, the SW550X device will wait for the set time before transferring another TCP data if the serial device side did not receive any data (no response from the serial device). The maximum value for this option is 60,000 milliseconds or 1 minute.

## Serial

- **Serial FIFO:** By default, SW550X has its First-In-First-Out (FIFO) function enabled to optimize its serial performance. In some applications (particularly when the flow control mechanism is enabled), it may deem necessary to disable the FIFO function to minimize the amount of data that is transmitted through the serial interface after a flow off event is triggered to reduce the possibility of overloading the buffer inside the serial device. Please note that disabling this option on baud rates higher than 115200bps would noticeably reduce the data integrity.
- **Serial Buffer:** By default, SW550X will empty its serial buffer when a new TCP connection is established. This means that the TCP application will not receive buffered serial data during a TCP link breakage. To keep the serial data when there is no TCP connection and send out the buffered serial data immediately after a TCP connection is established, you can disable this option.

After finish configuring the COM Port's **Advanced Settings**, please click on **Save & Apply** button to keep the change that you have made. There will be a "**Save Successfully**" message show up on the same browser window of **Advanced Settings** page. Then, the **Advanced Settings** browser window will be closed automatically and you will be returned to **COM 1 Port Setting** page.



## 4.6 Web configuration - SNMP/Alert Settings

The Simple Network Management Protocol (SNMP) is used by network management software to monitor devices in a network, to retrieve network status information of the devices, and to configure network parameters of the devices. The SNMP Settings page showed below allows user to configure SW550X device so that it can be viewed by third-party SNMP software.

SNMP/ALERT Settings
SW5502

SNMP/ALERT Settings

The *SNMP* is used in network management systems to monitor network-attached devices for conditions that warrant administrative attention.

Basic Data Objects	
System Contact	<input type="text" value="contact"/>
System Name	<input type="text" value="0060E90B4EB0"/>
System Location	<input type="text" value="location"/>
<b>SNMP</b>	<input type="checkbox"/> <b>Enable</b>
Read Community	<input type="text" value="public"/>
Write Community	<input type="text" value="private"/>
SNMP Trap Server	
SNMP Trap Server	<input type="text" value="0.0.0.0"/>

**Event alert settings**

Alert Type	Email	SNMP Trap
Cold start	<input type="checkbox"/>	<input type="checkbox"/>
Warm start	<input type="checkbox"/>	<input type="checkbox"/>
Wireless Disassociated	<input type="checkbox"/>	<input type="checkbox"/>
Wireless Associated	<input type="checkbox"/>	<input type="checkbox"/>
Authenticate failed	<input type="checkbox"/>	<input type="checkbox"/>
IP Address changed	<input type="checkbox"/>	
Password changed	<input type="checkbox"/>	

Figure 4.36 SNMP/Alert Settings Page

SW550X provides three basic SNMP fields which are: “**System Contact**” usually used to specify the device’s contact information in case of emergency (default value is “**contact**”), “**System Name**” usually used to identify this device (default value is the MAC Address of SW550X), and “**System Location**” usually used to specify the device location (default value is “**location**”). To make the device information available for public viewing/editing, you can enable the SNMP function by checking the **Enable** box and fill in the two passphrases (or SNMP Community Strings)

below it. By filling in the passphrase for the **“Read Community”**, SW550X device allows other network management software to read its information. By filling in the passphrase for the **“Write Community”**, SW550X device allows other network management software to read/modify its information. The default SW550X’s SNMP Community Strings (or passphrases) for **Read Community** and **Write Community** as shown in Figure 3.36 are **“public”** and **“private”**, respectively.

Additionally, you can setup a **SNMP Trap server** in the network to receive and collect all alert messages from SW550X. To configure SW550X to dispatch alert messages originated from any unexpected incidents, you can fill in the **IP Address** of the **SNMP Trap Server** in the field shown above. Note that any changes in these settings will take effect after the SW550X device is restarted.

Under the **SNMP Trap server**, there is a list of **Alert Type** under **Event alert settings** box. There are two possible actions for each alert event: **Email** and **SNMP Trap**. You can enable the associated action(s) of each alert event by checking the box under the column of **Email** and/or **SNMP Trap**. When the **Email** box is checked and the corresponding event occurs, it will trigger an action for SW550X to send an e-mail alert to designated addresses configured in the **E-Mail Settings** (described in the next section). When the **SNMP Trap** box is checked and the corresponding event occurs, it will trigger an action for SW550X to send a trap alert to the designated **SNMP Trap server**.

There are seven events that will trigger the alarm from SW550X as listed in figure above. These alerts are useful for security control or security monitoring of the SW550X device:

- **Cold Start:** This event occurs when there is a power interruption.
- **Warm Start:** This event occurs when the device resets.
- **Wireless Disassociated:** This event occurs when wireless interface (IEEE 802.11) of SW550X disassociates from an Access Point.
- **Wireless Associated:** This event occurs when wireless interface (IEEE 802.11) of SW550X associates with an Access Point.
- **Authentication Failure:** This event occurs when an incorrect username and/or password are entered which could indicate an unauthorized access to the SW550X.
- **IP Address Changed:** This event occurs when the SW550X device’s IP address is changed.
- **Password Changed:** This event occurs when the administrator password is changed.

After finish configuring the **SNMP/Alert Settings**, please click on **Save & Apply** button to keep the change that you have made and to apply your setting. A pop-up window with message **“Please wait for a while...”** will be displayed. When the saving and applying are finished, the pop-up window will disappear and the web browser will remain on the **SNMP/Alert Settings** page. If you want to cancel the change and reset all changes back to their original values, just click the **Cancel** button.

---

## 4.7 Web configuration - E-mail Settings

---

When SW550X device raises an alert and/or a warning message, it can send an e-mail to an administrator’s mailbox. This **E-mail Settings** page allows you to set up the SW550X to be able to send an e-mail. Figure below shows the **E-mail Settings** page in which there are two configurable parts: **E-mail Address Settings** and **E-mail Server**. First for the **E-mail Address Settings** part, a **Sender’s** e-mail address is required to be filled in the **Sender’s** text box which will be used in the **From** field of the e-mail. Note that the maximum length of sender email address is 48 characters. Then, for the **Receiver’s** text box you can enter multiple recipients which will be used in the **To**

field of the e-mail. Note that to fill in multiple receiver e-mail addresses in the **Receiver's** text box, please separate each e-mail address with semicolon (;).

Figure 4.37 E-mail Settings Page

Second for the **E-mail Server** part, you must enter an **IP address** or **Host Name** of a **Mail Server** which is in your local network in the **SMTP Server's** text box. Note that the maximum length of SMTP server address is 31 characters. If your Mail Server (or Simple Mail Transfer Protocol (SMTP) Server) requires a user authentication, you must check the **"SMTP server authentication required"** box in the **Authentication** option. After enabling this option, you can fill in the **Username** and the **Password** below. Please consult your local network administrator for the IP address of you Mail Server and the required Username and Password. At the end of the page, there is a **Send Test Mail** button for you to click to verify whether the **E-mail Settings** are configured correctly. Note that after clicking the **Send Test Mail** button, a pop-up window with message **"Please wait for a while..."** will be displayed and will be followed with another pop-up window indicating the success or failure status of sending test e-mail. Figure below shows a pop-up window indicating a failure of sending a test e-mail.

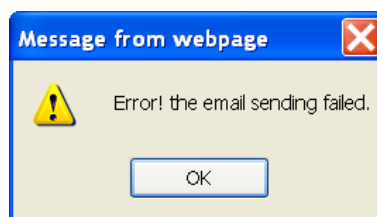

Figure 4.38 Sending Test E-mail Failed



### Attention

It is also important to setup Default Gateway and DNS Servers in the Network Settings properly so that SW550X can lookup domain names and route the e-mails to the proper default gateway. Please see the Default Gateway and DNS Server Settings in Section 4.3 above

After finish configuring the **E-mail Settings**, please click on **Save & Apply** button to keep the change that you have made and to apply your setting. A pop-up window with message “**Please wait for a while...**” will be displayed. When the saving and applying are finished, the pop-up windows will disappear and the web browser will remain on the **E-mail Settings** page. If you want to cancel the change and reset all changes back to their original values, just click the **Cancel** button.

## 4.8 Web configuration - Log Settings

### 4.8.1 System Log Settings

The Syslog function is turned on by default and cannot be turned off for SW550X. It is used to keep log for system events and report to an external Syslog server if necessary. Figure below shows the **System Log Settings** page under the **Log Settings** menu. Description of each option is as follows.

System Log Settings	
Enable Log Event to Flash	<input type="checkbox"/> Enabled
Enable Syslog Server	<input type="checkbox"/> Enabled
IP Address	<input type="text" value="0.0.0.0"/>
Syslog Server Service Port	<input type="text" value="514"/> (1-65535, default=514)
Enable Wireless Log	<input type="checkbox"/> Enabled
Save Kernel Log	<input type="button" value="Backup"/>

Figure 4.39 System Log Settings Page

- **Enable Log Event to Flash:** When the check box is enabled, SW550X will write log events to the local flash. Otherwise the log events would be cleared when the device restarts because they are stored in the RAM by default.
- **Enable Syslog Server:** When the check box is enabled, it will allow SW550X to send Syslog events to the remote Syslog server with the specified IP address (next option). All the data sent/received from serial interface will be logged and sent to Syslog Server.
- **IP Address:** The user must specify the IP address of a remote Syslog Server in this field.
- **Syslog Server Service Port:** This option allows user to specify the remote Syslog Server Port. Note that the default port number is 514.
- **Enable Wireless Log:** When the wireless log is enabled, the status of scan, authentication, connection, etc. will be captured.
- **Save Kernel Log:** Press the **Backup** button in this option to save all kernel log messages including wireless log to a file on the user’s PC.

After finish configuring the **System Log Settings**, please click on **Save & Apply** button to keep the change that you have made and to apply your setting. A pop-up window with message **“Please wait for a while...”** will be displayed. When the saving and applying are finished, the pop-up window will disappear and the web browser will remain on the **System Log Settings** page. If you want to cancel the change and reset all changes back to their original values, just click the **Cancel** button.

#### 4.8.2 COM Log Settings

Transmitted data through COM port could be logged for recording or debugging purposes. Additionally, the logs could be reported to an external Syslog server as well. Figure 3.40 shows the **COM Log Settings** page under the **Log Settings** menu. Description of each option is explained as follows.

Figure 4.40 COM Log Settings Page

- **Enable Log event to Flash:** When the Enabled box is checked, all the serial logs are saved into flash. The maximum number of files is 5, while each file contains 15K bytes.
- **Log Data Contents:** if this option is enabled, the COM logging function will log the content's data that is being transmitted and received in raw bytes. If this option is disabled, COM logging function will only log the length of data to reduce system load.
- **Data types:** There are two radio buttons which are hexadecimal (HEX) and ASCII for user to select the desired logged data's format.
- **COM Ports:** The user can select which port(s) will be logged by checking the corresponding boxes.
- **Enable Syslog Server:** Enabling this option would allow user to send COM logs to a remote Syslog server. It is possible to send COM logs to the same Syslog server used previously for event logging (See [Chapter 4.8 above](#)).
- **IP Address:** When the Syslog Server is enabled, please specify the remote Syslog server's IP address in this field.
- **Syslog Server Service Port:** This option allows user to specify the remote Syslog Server Port. Note that the default port number is 514.
- **Transfer Log Data by FTP:** If the Enabled box is checked for this option, the COM log will be sent out by FTP client every specific time interval. The user also needs to specify the next four fields for FTP data transfer.
- **FTP IP Address:** This is the IP address of the FTP server that the log will transfer to.

- **FTP Server Service Port:** This is the service port for FTP service. The default service port number for FTP server is 21. However, the user can specify the port number in between 1 and 65535.
- **FTP Username:** This is the username for an account on the FTP server. It will be used to login to the FTP server.
- **FTP Password:** This is the password for an account on the FTP server. It will be used to authenticate the account on the FTP server.
- **Transfer Log Data by Email:** When the Enabled box is checked for this option, a COM log will be sent out by E-mail every specific time interval (the next field). Note that the user must set up an E-mail information correctly to be able to transfer log data by E-mail as shown above. Please see the detail explanation of the E-mail Settings in [Chapter 4.7](#) above.
- **Transfer Time Interval:** This is an interval in hours that the user can specify for the log to be transferred.

After finish configuring the **COM Log Settings**, please click on **Save & Apply** button to keep the change that you have made and to apply your setting. A pop-up window with message **“Please wait for a while...”** will be displayed. When the saving and applying are finished, the pop-up window will disappear and the web browser will remain on the **COM Log Settings** page. If you want to cancel the change and reset all changes back to their original values, just click the **Cancel** button.

### 4.8.3 Event Log

This page displays the current event log stored in the SW550X device. Figure below shows an example of logged event. Each record of the log consists of **Index**, **Date**, **Time**, **Startup Time**, and **Event** description.

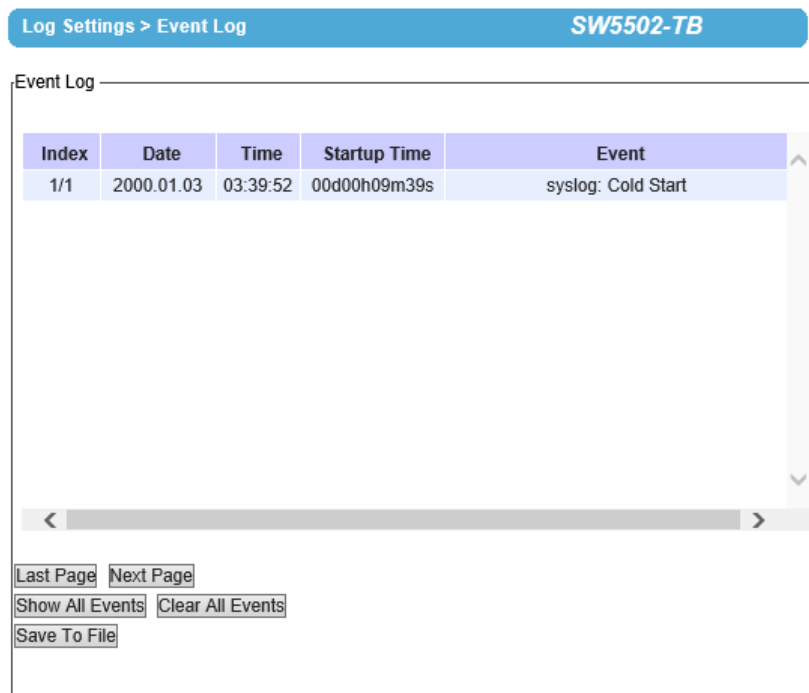

Figure 4.41 Event Log Page

At the end of the Event Log page, there are two buttons which can be used to navigate through all records. You can click on the **“Last Page”** button to go to the last page of the log and click on the **“Next Page”** button to go to the next page. To display all events in one page, you can click on **“Show All Events”** button. By clicking on **“Clear All**

Events” button, you can clear all events stored in the device and the Event Log will be empty with a message “There is no event”. To save all events to a local file (on your personal computer), you can click on “Save To File” button.

#### 4.8.4 COM DataLog

This page displays the current COM data log stored in the device. The desired COM port number can be selected from the **COM x Log** drop-down list in Figure 3.43, which allows it to display logs from different COM ports. An example of COM 1 Log is shown in Figure 3.43. The first three lines were set to log length of data while the last four lines were set to log data’s content. The letter **R** refers to “Received data” while letter **T** refers to “Transmitted data”. The number in the bracket, “()”, is the length of the data in Bytes. Each record of the log consists of **Index**, **Date**, **Time**, **Startup Time**, and **Event**.



Figure 4.42 COM Datalog Page

At the end of the **COM Datalog** page, there are two buttons which can be used to navigate through all records. You can click on the “**Last Page**” button to go to the last page of the log and click on the “**Next Page**” button to go to the next page. To display all events in one page, you can click on “**Show All Events**” button. By clicking on “**Clear All Events**” button, you can clear all events stored in the device and the **COM DataLog** will be empty with a message “**There is no event**”. To save all events to a local file (on your personal computer), you can click on “**Save To File**” button.

## 4.9 Web configuration – System Setup

### 4.9.1 Date/Time Settings

Date and time can be set manually or using **Network Time Protocol (NTP)** to automatically synchronize date and time of SW550X with a Time Server. Figure below shows the **Date/Time Settings** page. Note that the **Current Date/Time** will be updated automatically on this page. To enable automatic time synchronization, please check the **“Obtain date/time automatically”** box in the **NTP** option below **NTP Server Settings** part. Then proceed to enter the IP address or host name for the **NTP Server**. Note that if a host name is entered, the DNS server must be configured properly (see detail in [Section 4.3 above](#)). Additionally, a **Time Zone** can be selected as well from the drop-down list. **Daylight Saving Time Setting** is enabled when **Enable Daylight Saving Time** box is checked. When it is enabled, the user can select the detailed setting, such as **Start Date** and **End Date** with **Offset**. **Manual Time Settings** can be set in the lower part where user can set Date and Time using corresponding drop-down lists.

Figure 4.43 Date/Time Settings Page



**Attention**

It is also important to setup Default Gateway and DNS Servers in the Network Settings properly (See [Section 3.5](#)), so SW550X can lookup DNS names and point to the proper NTP server.

After finish configuring the Date/Time Settings, please click on Save & Apply button to keep the change that you have made and to apply your setting. A pop-up window with message “Please wait for a while...” will be displayed. When the saving and applying are finished, the pop-up window will disappear and the web browser will remain on



the Date/Time Settings page. If you want to cancel the change and reset all changes back to their original values, just click the Cancel button.

#### 4.9.2 Admin Settings

The SW550X Series allows user and password management through this **Admin Settings** page under **System Setup** menu. By default, the **user name** is "*admin*" and the **password** is "*default*". To set or change their values, you can enter the information in the **User name**, the **Old password**, the **New password** and the **Repeat new password** fields as shown below.

System Setup > Admin Settings SW5502

Admin Settings

Set up the login user name and password.

Account Settings	
User name	<input type="text" value="admin"/>
Old password	<input type="password"/>
New password	<input type="password"/>
Repeat new password	<input type="password"/>

Web mode	
Web mode	<input checked="" type="radio"/> HTTP <input type="radio"/> HTTPS

Figure 4.44 Admin Settings Page

There are two ways to access SW550X's Web User Interface (Web UI). The first one is via Hypertext Transfer Protocol (HTTP) and the other is via Hypertext Transfer Protocol Secure (HTTPS). For enhanced security, it is recommended to use the encrypted HTTPS protocol. Note that HTTP uses port 80 while HTTPS uses port 433. You can configure whether to add security layer (or encryption) for Web UI configuration via the **Web mode** option by choosing between **HTTP** and **HTTPS** radio buttons.

After finish configuring the Date/Time Settings, please click on Save & Apply button to keep the change that you have made and to apply your setting. A pop-up window with message "Please wait for a while..." will be displayed. When the saving and applying are finished, the pop-up window will disappear and the web browser will remain on the Date/Time Settings page. If you want to cancel the change and reset all changes back to their original values, just click the Cancel button.

### 4.9.3 Firmware upgrade

Updated firmware for SW550X is provided by Atop from time to time (for more information please visit Atop News & Events webpage) to fix bugs and optimize performance. It is very important that the device is **NOT turned off or powered off during the firmware upgrading**, (please be patient as this whole process might take up to 7 minutes). Before upgrading the firmware, please make sure that the device has a reliable power source that will not be powered off or restarted during the firmware upgrading process.

To upgrade a new firmware to SW550X, please downloaded the latest firmware for your SW550X model from the download tab on the SW550X product page or from the Download page under the Support link on Atop’s main webpage. Then, copy the new firmware file to your local computer. Note that the firmware file is a binary file with “.dld” extension. Next, open the Web UI and select **Firmware Upgrade** page under the **System Setup** menu. Then, click **“Browse”** button as shown in below Figure to find and choose the new firmware file. Then, click **“Upload”** button to start the firmware upgrade process. The program will show the upload status. Please wait until the uploading process is finished (the amount of time varies depending on the equipment used). Finally, the SW550X device will then proceed to restart itself. In some cases, you might require to re-configure your SW550X device. To restore your backup configuration from a file, please see the procedure in the next subsection.

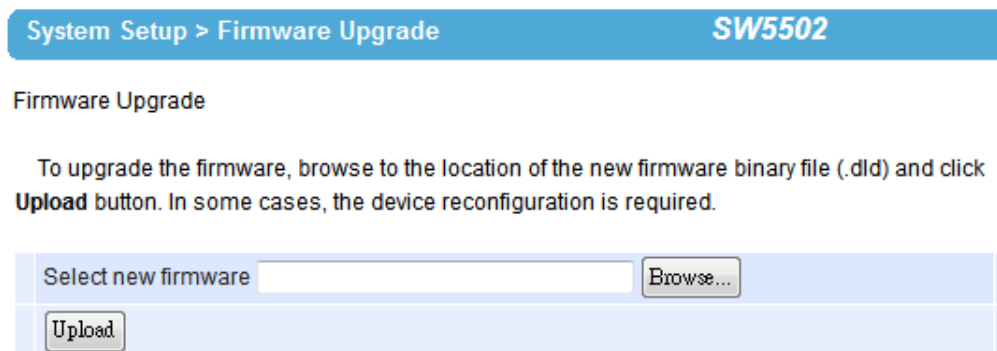

Figure 4.45 Firmware Upgrade Page

---

**Note:** if the firmware upgrade process fails and the device becomes unreachable, please follow the TFTP recovery procedure on the Emergency System Recovery.

---

### 4.9.4 Backup/Restore Settings

Once all the configurations are set and the device is working properly, the user should back up the current configuration of SW550X. The backup configuration file can be used when the new firmware is uploaded and the device is reset to a factory default settings. This is done to prevent accidental loading of incompatible old settings. The backup configuration file could also be used to efficiently deploy multiple SW550X Series devices of similar settings by uploading these settings to all devices.

To back up configuration, click **“Backup”** button under the **Backup Configuration** part as shown in below Figure, and a pop-up dialog will prompt the user for saving the backup file (station.ini) on user’s computer. It is important **NOT to manually modify the saved configuration file by any editor. Any modification to the file may corrupt the file and it may not be used for later restoration.**

Please contact Atop authorized distributors for more information on this subject.

To restore the backup configuration, click **“Browse”** button under the **Restore Configuration** part as shown in Figure below to locate the backup configuration file on user’s computer. Then, click on **“Upload”** button to upload the

backup configuration file to the device. Once the backup configuration file is successfully uploaded, the device will restart. Note that the time needed for this process may vary on the equipment used.

System Setup > Backup/Restore Setting SW5502

Backup & Restore Configuration

**Backup Configuration**  
Click **Backup** to save the current configuration to your computer.

**Restore Configuration**  
Browse a backup configuration file and click **Upload** button to restore the device's configuration.

Figure 4.46 Backup/Restore Setting Page

#### 4.9.5 Management List

The **Management List** is used to filter the MAC addresses that can have access to the Web management interface or Web UI. When **Management List** is enabled, only the MAC addresses entered in the list of allowed MAC address can gain access to the Web UI of SW550X. Check the radio button in front of the **“Allow uses with MAC addresses listed below”** to enable the MAC address list. Note that the **Access Control List** allows user to input up to 10 MAC addresses and must be entered in the XX:XX:XX:XX:XX:XX format (where XX are hexadecimal numbers).

System Setup > Management List SW5502

Management List

MAC address-based filtering method to control access to the device's web interface.

Disable Management List  
 **Allow uses with MAC addresses listed below**

The list of allowed MAC address	
MAC Address 1	<input type="text"/>
MAC Address 2	<input type="text"/>
MAC Address 3	<input type="text"/>
MAC Address 4	<input type="text"/>
MAC Address 5	<input type="text"/>
MAC Address 6	<input type="text"/>
MAC Address 7	<input type="text"/>
MAC Address 8	<input type="text"/>
MAC Address 9	<input type="text"/>
MAC Address 10	<input type="text"/>

Figure 4.47 Management List Page

After finish configuring the **Management List**, please click on **Save & Apply** button to keep the change that you have made and to apply your setting. A pop-up window with message “**Please wait for a while...**” will be displayed. When the saving is finished, the pop-up window will disappear and the web browser will remain on the **Management List** page. If you want to cancel the change and reset all changes back to their original values, just click the **Cancel** button.

#### 4.9.6 Ping

The Web UI of SW550X has an interface to call **Ping**, which is a network diagnostic utility for testing reachability. You can use the **Ping** function to determine whether SW550X can reach the gateway or other devices in the network. To use the **Ping**, enter a destination IP address in the text box behind the **Ping To** and click **Start** button as shown in Figure 3.49. This process usually takes around 20 seconds. The two figure below represent a successful ping without packet loss from SW550X to the address 10.0.50.201 and back, and the connecting device at the address 10.0.50.202 is unreachable in which no packets have returned from the transmitted ping packets.

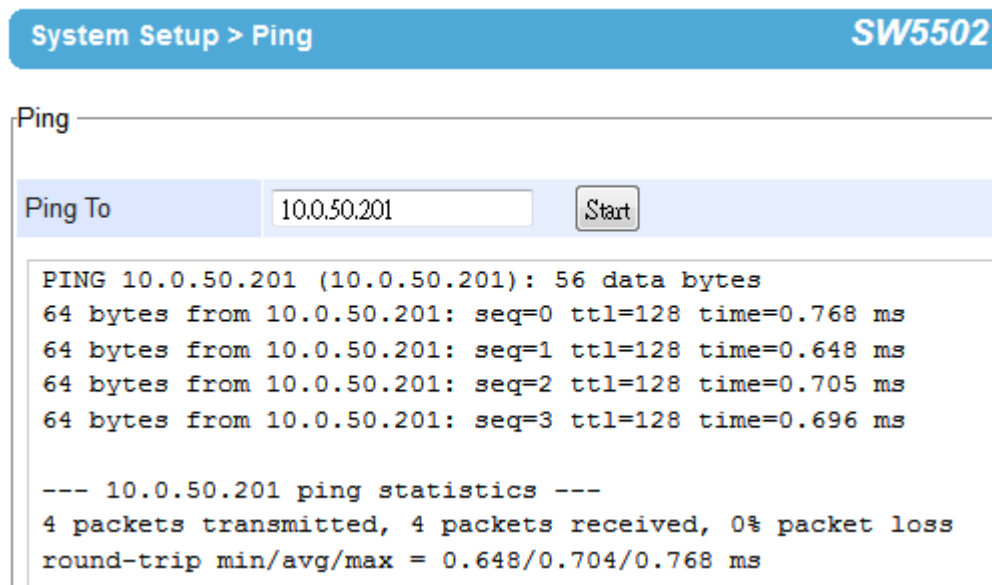

Figure 4.48 Successful Ping with No Packet Loss

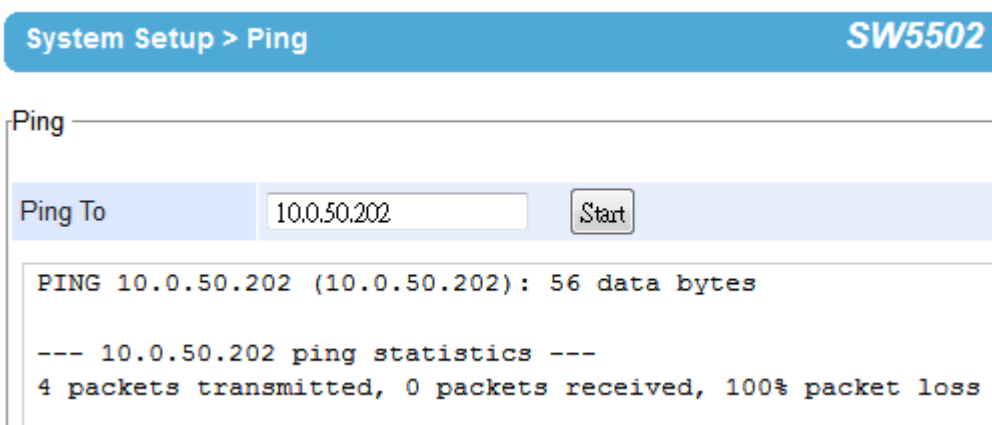

Figure 4.49 Unsuccessful Ping with 100% Packet Loss

#### 4.10 Web configuration – Reboot and Restore to default Settings

To manually reboot the SW550X device, click on the “**Reboot**” button at the end of the **Reboot** page. The device will then restart. A pop-up window with a message “**Please wait for a while...**” will be displayed with a countdown number in seconds. If a restoration to the factory default settings is needed, please check the “**Reset**” box before clicking on the **Reboot** button. When the rebooting process is finished, the pop-up window will disappear and the web browser will be redirected to the **Operation Mode** page.

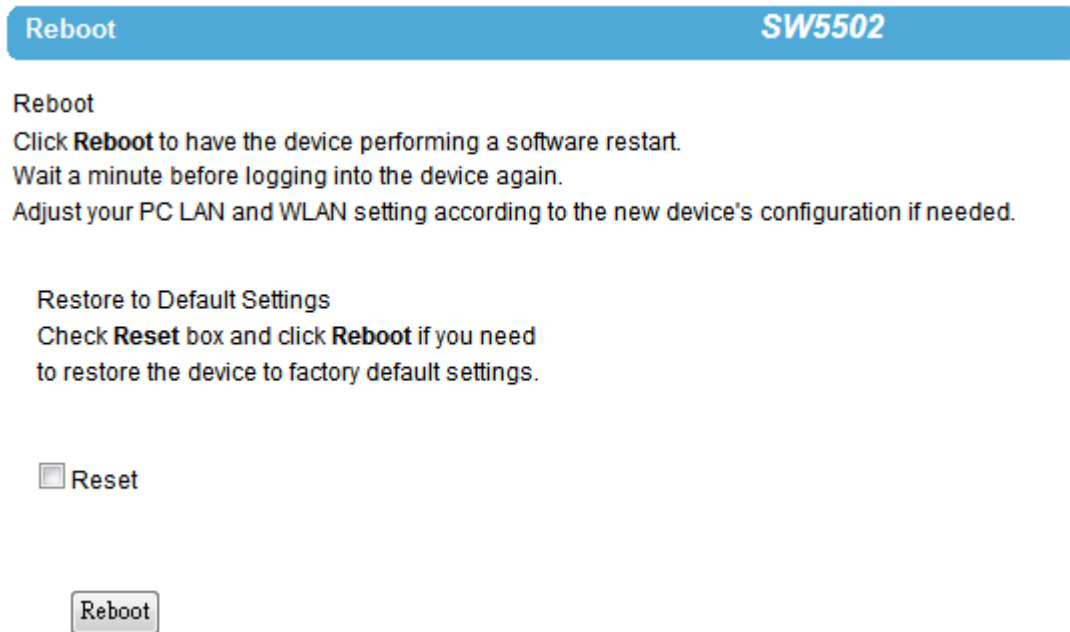

Figure 4.50 Reboot Page

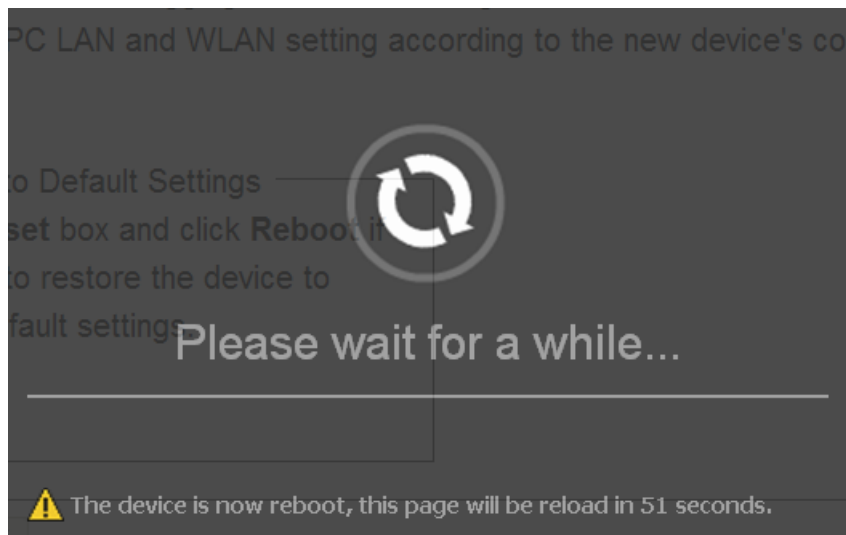

Figure 4.51 Pop-up Windows while Rebooting SW550X with Reloading Countdown in Seconds

## 5 Link modes and Applications

### 5.1 Link Mode Configuration

SW550X Series supports different Link Modes which are TCP Server, TCP Client, and UDP. The Link Mode describes the role of SW550X and the connection between SW550X device and other remote devices in the network which would like to communicate with serial devices on SW550X's COM ports. Under the three Link Modes, TCP Server mode can support RAW, Virtual COM, Reverse Telnet, or Pair Connection Master applications, while TCP Client mode can support RAW, Virtual COM, or Pair Connection Slave applications. Note that UDP mode does not have the same supported applications as the previous two TCP modes.

Discussion on how to setup different Link Modes properly will be presented in the following sections. Figure below show the Link Mode options for COM 1 port which can be found on **COM 1** page under **Serial** menu of Web UI (See details on Serial Settings in [Chapter 4.5 above](#)).

#### LINK Mode

To choose specific working mode for COM 1 port.

TCP Server  TCP Client  UDP

Figure 5.1 Link Mode Options for COM 1 Port

#### 5.1.1 Link Mode: Configure SW550X as a TCP Server

SW550X Series can be configured as a Transport Control Protocol (TCP) server in a TCP/IP network to listen for an incoming TCP client connection to a serial device. Figure 4.2 depicts an example of a PLC (serial) device which is connected to SW550X on a serial bus where a remote host computer is sending a request via Ethernet network. After the connection is established between the serial device server (SW550X) and the remote host computer (remote TCP client) in the figure, data can be transmitted in both directions. This also applies whenever the Virtual COM (VCOM) application is running on server mode. Please note that this is the SW550X device's default link mode.

#### TCP Server Mode

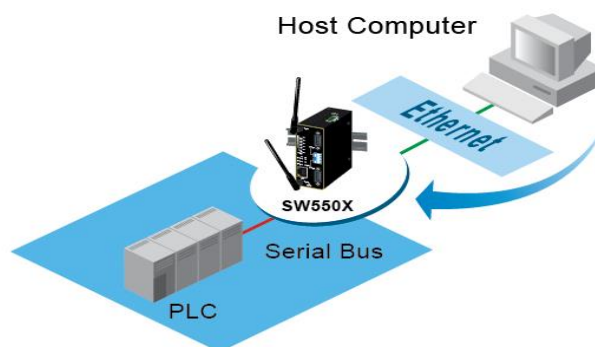

Figure 5.2 An Example of TCP Server Link Mode

The default Link Mode of SW550X is the TCP Server mode. Below an example of configuration setting for TCP Server Link Mode under the COM 1 page. There are additional connection settings that can be configured as shown in Figure below. By selecting the TCP Server Link Mode, a TCP Client program on a remote host computer should be prepared to connect to SW550X. Please follow the following steps to configure connection settings of the Link Mode for each COM port.

**LINK Mode**

To choose specific working mode for COM 1 port.

TCP Server  TCP Client  UDP

<i>TCP Server</i>	
Application	RAW <input type="button" value="v"/>
IP Filter	<input type="checkbox"/> Enable
Source IP	<input type="text" value="0"/> . <input type="text" value="0"/> . <input type="text" value="0"/> . <input type="text" value="0"/>
Local Port	<input type="text" value="4660"/>
Maximum Connection	1 <input type="button" value="v"/>
Response Behavior	<input type="radio"/> Request & Response Mode <input type="radio"/> Reply to requester only <input checked="" type="radio"/> Reply to all <input checked="" type="radio"/> Transparent Mode

Figure 5.3 Connection Settings for TCP Server Link Mode

- Click on the **COM1** link on the menu frame on the left hand side of Web UI to go to COM 1 page as shown in Figure 4.4. Note that if you would like to configure COM 2, please follow the same procedures.

Serial > COM1
SW5502

**COM 1 Port Settings**

**LINK Mode**  
To choose specific working mode for COM 1 port.

TCP Server
  TCP Client
  UDP

**TCP Server**

Application	Virtual COM <span style="float: right;">v</span>
IP Filter	<input type="checkbox"/> Enable
Source IP	0 . 0 . 0 . 0
Local Port	4660
Maximum Connection	1 <span style="float: right;">v</span>
Response Behavior	<input type="radio"/> Request & Response Mode <input type="radio"/> Reply to requester only <input checked="" type="radio"/> Reply to all <input checked="" type="radio"/> Transparent Mode

To configure COM 1 port parameters.

**Serial Settings**

Serial Interface	<input checked="" type="radio"/> RS232 <input type="radio"/> RS422 <input type="radio"/> RS485(2-Wire) <input type="radio"/> RS485(4-Wire)
Baud Rate	38400 <span style="float: right;">v</span> bps
Parity	<input type="radio"/> None <input type="radio"/> Odd <input checked="" type="radio"/> Even <input type="radio"/> Mark <input type="radio"/> Space
Data bits	<input type="radio"/> 5 bits <input type="radio"/> 6 bits <input checked="" type="radio"/> 7 bits <input type="radio"/> 8 bits
Stop bits	<input type="radio"/> 1 bit <input checked="" type="radio"/> 2 bits
Flow Control	<input checked="" type="radio"/> None <input type="radio"/> Xon/Xoff <input type="radio"/> RTS/CTS

Figure 5.4 TCP Server Link Mode Settings under COM 1 Page

- Select **TCP Server** radio button in the Link Mode options. Note that **TCP Server** is the default **Link Mode** for COM port of SW550X.
- Under the **TCP Server** section, you will find the following options.
  - ◆ **Application:** There are 4 different communication applications to choose from here:
    - **RAW:** There is no protocol on this mode which means that the data is passed transparently.
    - **Virtual COM:** The Virtual COM protocol is enabled on the serial device to communicate with a virtualized port from a remote client. It is possible to create a Virtual COM port on Windows/Linux in order to communicate with the serial device as a remote client.
    - **Reverse Telnet:** This application is used to connect the serial device and another serial device (usually a Terminal Server) with a Telnet program. Telnet programs in Windows/Linux usually



require special handshaking to get the outputs and formatting to show properly. The SW550X series will interact with those special commands (CR/LF commands) once **Reverse Telnet** application is enabled.

- **Pair Connection Master:** This application is used when the user want to pair two serial devices over the Ethernet network.
- ◆ **IP Filter:** This option will enable the **Source IP** option below. When this option is checked, SW550X will block or filter out all other IP addresses from accessing the COM port except the one specified in the **Source IP**.
- ◆ **Source IP:** This option specifies the remote client's Source IP which will be transmitting data to our TCP Server (on SW550X). In other words, our TCP Server will only allow data from this IP address to flow (hence its own name implies Source IP). Note that only one source is allowed.
- ◆ **Local Port:** This option specifies the port number that the TCP Server (on SW550X) should listen to. It is also used by the remote TCP client to connect to the TCP server. The default local port is 4660. You can enter different port number in this option.
- ◆ **Maximum Connection:** This option specifies the maximum number of remote devices/clients (with maximum of 4 clients) that can be connected to the serial device on this COM port.
- ◆ **Response Behavior:** This option specifies how SW550X will proceed or behave when it receives requests from remote connected hosts in which we will have the following options:
  - **Request & Response Mode:** Under this mode, the COM port on SW550X will hold requests from all other remote connected hosts until the serial device replies or the Response Interval Timeout takes into effect to discard it; however, unrequested data sent from the serial device would be forwarded to all connected hosts. Additionally, user can specify how a reply message from the serial device will be sent to the remote connected hosts with two possible options:
    - **Reply to requester only:** The COM port will reply to the remote connected host who has requested the data only.
    - **Reply to all:** A reply is sent to all remote connected hosts.
  - **Transparent mode:** The COM port on SW550X will forward requests from all remote connected hosts to the serial device immediately and reply to all remote connected hosts once it receives data from the serial device.
- For other **Serial Settings** on the same configuration page please go to [Section 4.5.2](#) and for **Advanced Settings** please go to [4.5.3 above](#).
- After finish configuring the Link Mode, please scroll down to the bottom of the page and click on "**Save & Apply**" button to save all the changes that you have made.

---

**Note:** LINK1 is associated with COM1; LINK2 is associated with COM2, and so on.

---

**5.1.2 Link Mode: Configure SW550X as a TCP Client**

SW550X Series can be configured as a TCP client in TCP/IP network to establish a connection to a TCP server on a remote host computer. Figure 5.5 depicts an example of two serial card readers connected to two different SW550X devices where both SW550X devices are on the same Ethernet network as the remote host computer. The arrow in Figure 5.6 indicates the connection request from the client side of TCP connection. After the connection is established, data can be transmitted between a serial device (connected to the COM port of SW550X) and a remote host computer in both directions. This also applies to Virtual COM application running in the client mode.

**TCP Client Mode**

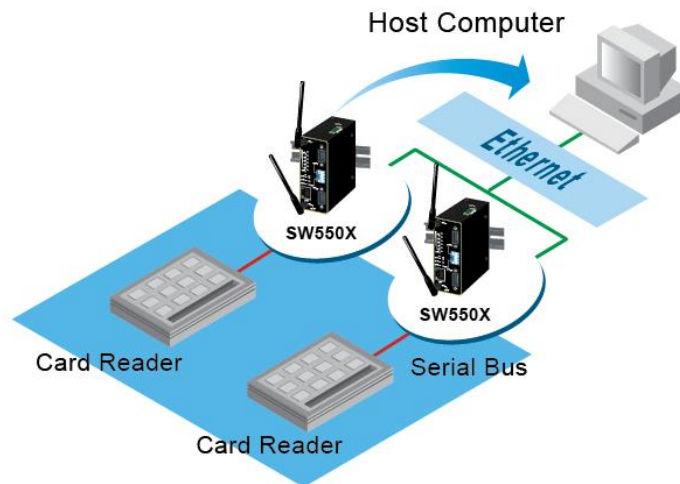

Figure 5.5 An Example of TCP Client Link Mode

Below is shown an example of configuration setting for TCP Client Link Mode under the COM 1 page. There are additional connection settings that can be configured. By selecting the TCP Client Link Mode, a TCP Server program on a remote host computer should be prepared to accept a connection request from SW550X. Please follow the following steps to configure connection settings of the Link Mode for each COM port.

TCP Server 
  TCP Client 
  UDP

<i>TCP Client</i>	
Application	R.A.W
Destination IP 1	10 . 0 . 50 . 1
Destination Port 1	4660
Destination 2	<input type="checkbox"/> Enable
Destination IP 2	0 . 0 . 0 . 0
Destination Port 2	4660
Response Behavior	<input type="radio"/> Request & Response Mode <input type="radio"/> Reply to requester only <input checked="" type="radio"/> Reply to all <input checked="" type="radio"/> Transparent Mode

Figure 5.6 Connection Settings for TCP Client Link Mode

- Click on the **COM1** link on the menu frame on the left side of Web UI to go to COM 1 page as shown in Figure 4.7. Note that if you would like to configure COM 2, please follow the same procedures.

Serial > COM1
SW5502

---

COM 1 Port Settings

**LINK Mode**  
To choose specific working mode for COM 1 port.

TCP Server
  TCP Client
  UDP

*TCP Client*

Application	Virtual COM <span style="float: right;">▼</span>
Destination IP 1	0 . 0 . 0 . 0
Destination Port 1	4660
Destination 2	<input type="checkbox"/> Enable
Destination IP 2	0 . 0 . 0 . 0
Destination Port 2	4660
Response Behavior	<input type="radio"/> Request & Response Mode <input type="radio"/> Reply to requester only <input checked="" type="radio"/> Reply to all <input checked="" type="radio"/> Transparent Mode

To configure COM 1 port parameters.

*Serial Settings*

Serial Interface	<input checked="" type="radio"/> RS232 <input type="radio"/> RS422 <input type="radio"/> RS485(2-Wire) <input type="radio"/> RS485(4-Wire)
Baud Rate	38400 <span style="float: right;">▼</span> bps
Parity	<input type="radio"/> None <input type="radio"/> Odd <input checked="" type="radio"/> Even <input type="radio"/> Mark <input type="radio"/> Space
Data bits	<input type="radio"/> 5 bits <input type="radio"/> 6 bits <input checked="" type="radio"/> 7 bits <input type="radio"/> 8 bits
Stop bits	<input type="radio"/> 1 bit <input checked="" type="radio"/> 2 bits
Flow Control	<input checked="" type="radio"/> None <input type="radio"/> Xon/Xoff <input type="radio"/> RTS/CTS

Figure 5.7 TCP Client Link Mode Settings under COM 1 Page

- Select **TCP Client** radio button in the Link Mode options.
- Under the **TCP Client** section, you will find the following options.
  - ◆ **Application:** Only three communication applications are available here: **RAW**, **Virtual COM** and **Pair Connection Slave** in which their definitions are the same as described in Section [5.1.1](#) above.
  - ◆ **Destination IP 1:** Please specify the preferred **Destination IP** address of the TCP Server program on the remote host in this field. This should match the IP settings of the TCP Server program.
  - ◆ **Destination Port 1:** Please specify the preferred **Port** number of the TCP Server program on the remote host in this field. Once again, this should match the IP setting of the TCP Server program.

- ◆ **Destination 2:** You can enable second remote destination for TCP connection if necessary by checking on the **Enable** box in this option. Two different TCP servers can be set for redundancy.
- ◆ **Destination IP 2:** Please specify the preferred **Destination IP** address of the second TCP Server program on the remote host in this field. This should match the IP settings of the second TCP Server program.
- ◆ **Destination Port 2:** Please specify the preferred **Port** number of the second TCP Server program on the remote host in this field. Once again, this should match the IP setting of the second TCP Server program.
- ◆ **Response Behavior:** This option specifies how SW550X will proceed or behave when it receives request from remote connected hosts. The description of each option is the same as described in previous subsection (Section 5.1.1 above).
- For other **Serial Settings** on the same configuration page please go to [Section 4.5.2](#) and for **Advanced Settings** please go to [4.5.3 above](#).
- After finish configuring the Link Mode, please scroll down to the bottom of the page and click on "**Save & Apply**" button to save all the changes that you have made.

### 5.1.3 Link Mode: Configure SW550X in UDP

Since User Datagram Protocol (UDP) is a faster transport protocol than TCP but it is a connectionless transport protocol, it does not guarantee the delivery of network datagram. SW550X also supports connectionless UDP protocol compared to the connection-oriented TCP protocol. The SW550X Series can be configured to transfer data using unicast or multicast UDP from the serial device to one or multiple host computers. The data can be transmitted between a serial device and a remote host computer in both directions.

There is no **server** or **client** concept on this protocol. All networked devices are called **peers** or **nodes**. Therefore, you only need to specify the **Local Port** that SW550X should listen to and specify the **Destination IPs** of the remote **UDP nodes**. Figure below illustrates an example of UDP Link Mode in which a serial display device is connected on a serial bus and SW550X. Two remote host computers, which are on the same Ethernet network as SW550X, can both send UDP datagram or messages to the serial display device through SW550X.

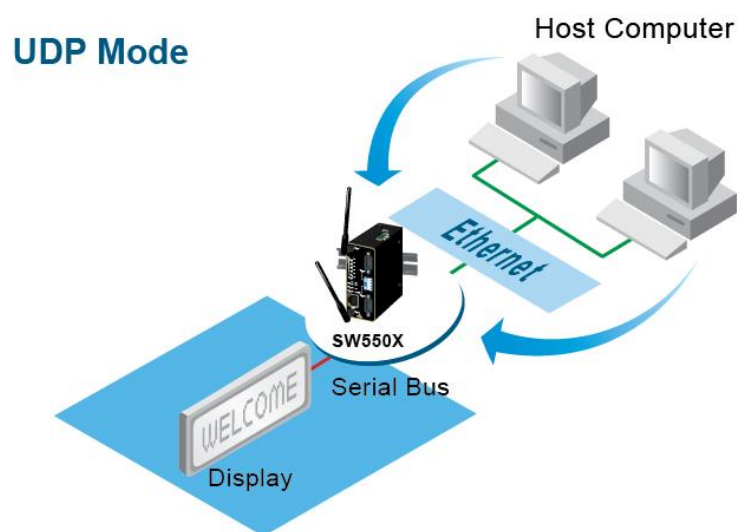

Figure 5.8 An Example of UDP Link Mode

Figure 5.9 shows an example of configuration setting for UDP Link Mode under the COM 1 page. There are additional connection settings that can be configured as shown below. Please beware that even though UDP provides better efficiency in terms of response time and resource usage, it does not guarantee data delivery. It is recommended to utilize UDP only with cyclic polling protocols where each request is repeated and independent, such as Modbus Protocol. Please follow the following steps to configure connection settings of the Link Mode for each COM port.

**LINK Mode**  
To choose specific working mode for COM 1 port.

TCP Server
  TCP Client
  UDP

UDP							
Local Port: 4660							
<input checked="" type="checkbox"/> Destination IP Address 1	10	.	0	.	50	. 1 ~ 100	Port: 4660
<input type="checkbox"/> Destination IP Address 2	0	.	0	.	0	. 0 ~ 0	Port: 4660
<input type="checkbox"/> Destination IP Address 3	0	.	0	.	0	. 0 ~ 0	Port: 4660
<input type="checkbox"/> Destination IP Address 4	0	.	0	.	0	. 0 ~ 0	Port: 4660

Figure 5.9 Connection Setting for UDP Link Mode

- Click on the **“COM1”** link on the menu frame on the left side of Web UI to go to COM 1 page as shown below. Note that if you would like to configure COM 2, please follow the same procedures.

**LINK Mode**  
To choose specific working mode for COM 1 port.

TCP Server
  TCP Client
  UDP

UDP							
Local Port: 4660							
<input checked="" type="checkbox"/> Destination IP Address 1	0	.	0	.	0	. 0 ~ 0	Port: 4660
<input type="checkbox"/> Destination IP Address 2	0	.	0	.	0	. 0 ~ 0	Port: 4660
<input type="checkbox"/> Destination IP Address 3	0	.	0	.	0	. 0 ~ 0	Port: 4660
<input type="checkbox"/> Destination IP Address 4	0	.	0	.	0	. 0 ~ 0	Port: 4660

To configure COM 1 port parameters.

Serial Settings	
Serial Interface	<input checked="" type="radio"/> RS232 <input type="radio"/> RS422 <input type="radio"/> RS485(2-Wire) <input type="radio"/> RS485(4-Wire)
Baud Rate	38400 bps
Parity	<input type="radio"/> None <input type="radio"/> Odd <input checked="" type="radio"/> Even <input type="radio"/> Mark <input type="radio"/> Space
Data bits	<input type="radio"/> 5 bits <input type="radio"/> 6 bits <input checked="" type="radio"/> 7 bits <input type="radio"/> 8 bits
Stop bits	<input type="radio"/> 1 bit <input checked="" type="radio"/> 2 bits
Flow Control	<input checked="" type="radio"/> None <input type="radio"/> Xon/Xoff <input type="radio"/> RTS/CTS

Figure 5.10 UDP Link Mode Settings under COM 1 Page

- Select **UDP** radio button in the Link Mode options.
- Under the **UDP** section, you will find the following options.
  - ◆ **Local Port:** This field specifies the local port number for UDP Link Mode on SW550X which it will be listening to and it can be any number between 1 and 65535. Note that typically the port number that is larger than 1024 is recommended to avoid conflicting with the well-known port numbers. You should match this setting with the remote UDP program. Note that this number is usually called destination port in the remote UDP program.
  - ◆ **Destination IP Address 1 to 4 and its Port Numbers:** Each line of these options can specify the range of IP addresses and port number that will be communicating with SW550X. The user can define the **Begin** and **End IP Addresses** here. Four groups of range of IP addresses are allowed. Please check the box in front of that particular line to enable it. These are the **IP Addresses** of the remote UDP programs and the **Port** that they are listening to. Note that the maximum number of UDP nodes that SW550X can handle would highly depend on the traffic load. *We have tested that SW550X can handle up to 200 UDP nodes (with baud rate of 9600 bps, request interval of 100ms, and data length of 30 bytes).*
- For other **Serial Settings** on the same configuration page please go to [Section 4.5.2](#) and for **Advanced Settings** please go to [4.5.3](#) above.

After finish configuring the Link Mode, please scroll down to the bottom of the page and click on “**Save & Apply**” button to save all the changes that you have made.

## 5.2 Link Mode Applications

This section describes application options for the TCP Server, TCP Client, and UDP Link Modes. The application options will define how the serial data communication will be emulated over the network communication link. The user will have flexibility in choosing the suitable application that matches their need for serial data communication.

### 5.2.1 TCP Server Application: Enable VirtualCOM

SW550X will encapsulate control packets on top of the real data when Virtual COM is enabled. This will allow the Virtual COM port on the Windows/Linux operating system to access SW550X's COM ports. The benefit of using Virtual COM is that rewriting an existing COM program to read IP packets is unnecessary. In other words, it is possible to use an ordinary or legacy serial (COM) program. The conversion/virtualization of IP to COM is all done in the system driver transparently. Figure below shows SW550X in TCP Server mode with Virtual COM enabled. Please follow the following steps to enable Virtual COM application in TCP Server Link Mode.

#### LINK Mode

To choose specific working mode for COM 1 port.

TCP Server  TCP Client  UDP

TCP Server	
Application	Virtual COM
IP Filter	<input type="checkbox"/> Enable
Source IP	0 . 0 . 0 . 0
Local Port	4660
Maximum Connection	1
Response Behavior	<input type="radio"/> Request & Response Mode <input type="radio"/> Reply to requester only <input checked="" type="radio"/> Reply to all <input checked="" type="radio"/> Transparent Mode

Figure 5.11 Virtual COM Application in TCP Server Link Mode

- Follow steps in Chapter Link Mode: Configure SW550X as a TCP Server 5.1.1 above to configure SW550X in TCP Server Link Mode properly.
- Click on the drop-down list of the **Application** option under TCP Server section and switch to **"Virtual COM"** to enabled Virtual COM application in SW550X.
- Scroll down to the bottom of the page and click on **"Save & Apply"** button to save the changes.

Configure Virtual COM in the Operating System on the remote host computer. For Windows, please refer to [Chapter 6 below](#) for necessary instructions. Please remember SW550X's IP address and the **Local Port** number configured on this page in order to enter the same information in Serial/IP Virtual COM's Control Panel later.

**Note:** that a Serial/IP Virtual COM Redirector software is provided as a utility software by Atop Technologies.

### 5.2.2 TCP Server Application: Enable RFC 2217 through Virtual COM

The underlying protocol of Virtual COM is based on RFC 2217 which is the Telnet COM Control Option. Therefore, it is possible to use RFC 2217 with SW550X in the TCP Server mode. Note that the RFC 2217 allows a remote client, which can be any network device, to initiate a Telnet session to an access server (i.e. SW550X) to communicate with serial device on the access server’s COM port. To do so, please refer to [5.2.1 above](#) to enable Virtual COM so that SW550X becomes aware of the command names and codes defined in RFC 2217. Note that there is no need to configure Virtual COM on the Operating System of the remote host computer because Virtual COM ports would not be used.

### 5.2.3 TCP Client Application: Enable Virtual COM

It is also possible to run Virtual COM in TCP Client Link Mode. Figure below shows a configuration of Virtual COM application in TCP Client Link Mode. It is usually easier to use Virtual COM in the TCP Client Link Mode if SW550X uses dynamic IP (via DHCP) because setting a static IP address in Virtual COM’s Control Panel in the Operating System is not possible. Please follow the following steps to enable Virtual COM application in TCP Client Link Mode.

**LINK Mode**  
To choose specific working mode for COM 1 port.

TCP Server
  TCP Client
  UDP

<i>TCP Client</i>	
Application	Virtual COM ▾
Destination IP 1	10 . 0 . 50 . 1
Destination Port 1	4660
Destination 2	<input type="checkbox"/> Enable
Destination IP 2	0 . 0 . 0 . 0
Destination Port 2	4660
Response Behavior	<input type="radio"/> Request & Response Mode <input type="radio"/> Reply to requester only <input checked="" type="radio"/> Reply to all <input checked="" type="radio"/> Transparent Mode

Figure 5.12 Virtual COM Application in TCP Client Link Mode

- Follow step in Paragraph [5.1.2 above](#) to configure SW550X in TCP Client Link Mode properly.
- Click on the drop-down list of the **Application** option under TCP Client section and switch to **“Virtual COM”** to enabled Virtual COM application in SW550X.
- Scroll down to the bottom of the page and click on **“Save & Apply”** button to save the changes.
- Configure Virtual COM in the Operating System on the remote host computer. For Windows, please refer to [Chapter 6 below](#) for the related instruction. Please remember the **Destination Port** number configured on this page in order to enter this information in Serial/IP Virtual COM’s Control Panel later.



### 5.2.4 TCP Client Application: Enable RFC 2217 through Virtual COM

The underlying protocol of Virtual COM is based on RFC 2217, which is the Telnet COM Control Option. Therefore, it is possible to use RFC 2217 with SW550X in the TCP Client mode. Note that the RFC 2217 allows a client, which is SW550X in this case, to initiate a Telnet session to a remote host computer to communicate with serial device or serial (COM) program on the remote host computer. To do so, please refer to Paragraph 5.2.3 above to enable Virtual COM so that SW550X becomes aware of the command names and codes defined in RFC 2217. Note that there is no need to configure Virtual COM on the Operation System of the remote host computer because Virtual COM ports would not be used.

### 5.2.5 TCP Client Application: Configure SW550X as a Pair Connection Master

A Pair Connection application is useful when pairing up two serial devices over the Ethernet or when it is impossible to install Virtual COM in the serial devices. However, the pair connection application does require two SW550Xs to work in pair. One would be the Pair Connection Master and the other would be the Pair Connection Slave. Figure [below](#) shows a configuration of Pair Connection Master application in TCP Server Link Mode. Please follow the following steps to enable Pair Connection application and set the SW550X as Master in TCP Server Link Mode.

**LINK Mode**  
To choose specific working mode for COM 1 port.

TCP Server
  TCP Client
  UDP

<i>TCP Server</i>	
Application	Pair Connection Master ▼
IP Filter	<input type="checkbox"/> Enable
Source IP	<input type="text" value="0"/> . <input type="text" value="0"/> . <input type="text" value="0"/> . <input type="text" value="0"/>
Local Port	<input type="text" value="4660"/>
Maximum Connection	1 ▼
Response Behavior	<input type="radio"/> Request & Response Mode <input type="radio"/> Reply to requester only <input checked="" type="radio"/> Reply to all <input checked="" type="radio"/> Transparent Mode

Figure 5.13 Pair Connection Master Application in TCP Server Link Mode

- Follow steps in Paragraph 5.1.1 above to configure SW550X in TCP Server Link Mode properly.
- Click on the drop-down list of the **Application** option under TCP Server section and switch to **“Pair Connection Master”** to enable Pair Connection application in SW550X.
- Scroll down to the bottom of the page and click on **“Save & Apply”** button to save the changes.
- Please remember Pair Connection Master’s IP address (i.e. SW550X’s IP address on your desired network interface (either Ethernet or Wi-Fi)) and Local Port number here in order to enter these information in another SW550X device with the Pair Connection Slave setting later.
- Proceed to the Paragraph below to configure a Pair Connection Slave to connect to this Master.

### 5.2.6 TCP Client Application: Configure SW550X as a Pair Connection Slave

A **Pair Connection Slave** application is configured for SW550X under TCP Client Link. It is necessary to pair up with a **Pair Connection Master** as described in previous section. Please setup a **Pair Connection Master** on another SW550X device first before proceeding. Please follow the following steps to enable Pair Connection application and set this SW550X device as Slave in TCP Client Link Mode.

#### LINK Mode

To choose specific working mode for COM 1 port.

TCP Server  TCP Client  UDP

TCP Client	
Application	Pair Connection Slave ▾
Destination IP 1	10 . 0 . 50 . 1
Destination Port 1	4660
Destination 2	<input type="checkbox"/> Enable
Destination IP 2	0 . 0 . 0 . 0
Destination Port 2	4660
Response Behavior	<input type="radio"/> Request & Response Mode <input type="radio"/> Reply to requester only <input checked="" type="radio"/> Reply to all <input checked="" type="radio"/> Transparent Mode

Figure 5.14 Pair Connection Slave Application in TCP Client Link Mode

- Follow steps in Paragraph 5.1.2 above to configure SW550X in TCP Client Link Mode properly.
- Click on the drop-down list of the **Application** option under TCP Client section and switch to "**Pair Connection Slave**" to enabled Pair Connection application in SW550X.
- Enter the **Destination IP** address and the **Destination Port** number (for Destination 1 and (optionally Destination 2)) that match to the settings of Pair Connection Master (another SW550X device)'s IP and port number that were setup previously.
- Scroll down to the bottom of the page and click on "**Save & Apply**" button to save the changes.

### 5.2.7 TCP Server Application: Enable Reverse Telnet

Reverse Telnet application is useful if a Telnet program is used to connect to SW550X and the serial interface of the SW550X is connected to a Terminal Server. Telnet programs in Windows/Linux operating systems require special handshaking to get the outputs and the character formatting to show properly. SW550X will interact with those special commands (such as CR/LF commands) if Reverse Telnet is enabled. Figure 5.15 shows a configuration of Reverse Telnet application in the TCP Server Link Mode. Note that the Reverse Telnet application is only available when SW550X is configured as TCP Server Link Mode. Please follow the following steps to enable Reverse Telnet application under the TCP Client Link Mode.

**LINK Mode**

To choose specific working mode for COM 1 port.

TCP Server  TCP Client  UDP

TCP Server	
Application	Reverse Telnet <span style="float: right;">▼</span>
IP Filter	<input type="checkbox"/> Enable
Source IP	0 . 0 . 0 . 0
Local Port	4660
Maximum Connection	1 <span style="float: right;">▼</span>
Response Behavior	<input type="radio"/> Request & Response Mode <input type="radio"/> Reply to requester only <input checked="" type="radio"/> Reply to all <input checked="" type="radio"/> Transparent Mode

Figure 5.15 Reverse Telnet Application in TCP Server Link Mode

- Follow steps in Paragraph 5.1.1 above to configure SW550X in TCP Server Link Mode properly.
- Click on the drop-down list of the **Application** option under TCP Server section and switch to **“Reverse Telnet”** to enabled reverse telnet application in SW550X.

Scroll down to the bottom of the page and click on **“Save & Apply”** button to save the changes.

**5.2.8 UDP Application: Multi-Point Pair Connection**

It is also possible to setup pair connection application in UDP Link Mode to have more than one Pair Connection Master or Slave to communicate with each other. For example, it is possible to setup one Modbus Master and six Modbus Slaves in UDP Link Mode. Figure 5.16 shows an example of one Modbus Master serially connected to a SW550X, which is a Pair Connection Master in UDP Link Mode, while four other SW550Xs are serially connected to one or two Modbus Slaves and configured as Pair Connection Slaves in UDP Link Mode. Note that all SW550X devices are communicated over the same wireless network. Note again that UDP does not guarantee data delivery and only data would be transmitted over Ethernet or Wi-Fi networks while other serial pings are not transmitted. If RS-232 data along with its flow control pin data are required to be exchanged over the network (as if COM interfaces of these devices were connected without SW550X), it is recommended to use Multi-Point Pair Connection using TCP, please see detail in [Paragraph 5.2.10 below](#). To configure Multi-Point Pair Connection in UDP Link Mode, please see an example and set the required parameters of each SW550X in Table 5.1 using the steps described in [Paragraph 5.1.3 above](#).

---

**Note:** the destination IP addresses and port numbers of the slaves need to be equal to the master’s IP address and port number. Local listening port numbers of the slaves need to be equal to the master’s destination port number. Please see [Table 5.1](#) for an example.

---

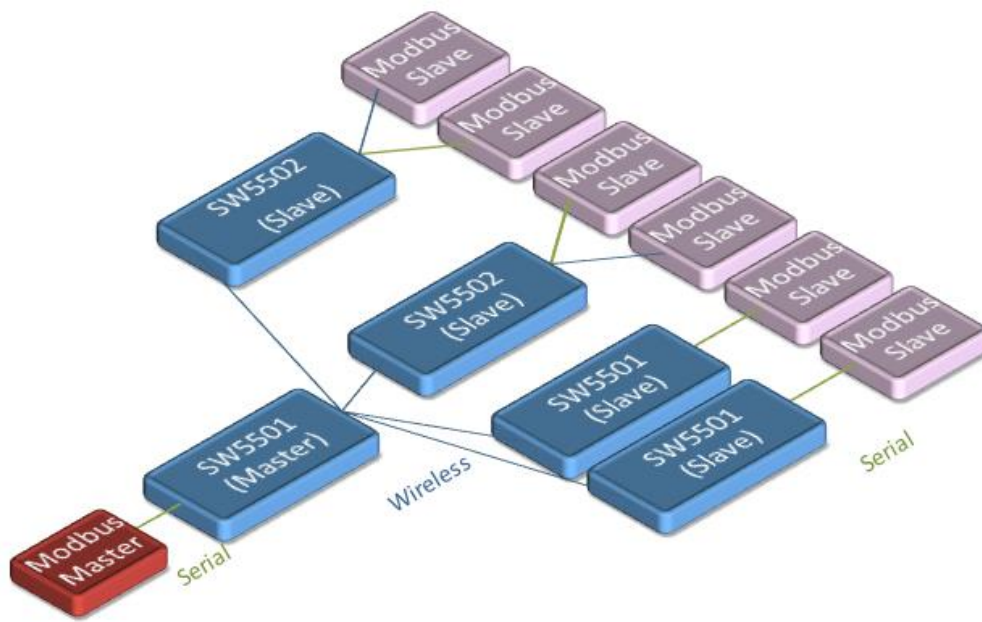

Figure 5.16 An Example of Network Topology for Multi-Point Pair Connection in UDP Link Mode

Table 5.1 An Example of Multi-Point Pair Connection’s Parameter Settings for UDP Link Mode

	IP Address	Link Mode	Local Listening Port	Destination IP	Destination Port
SW5501 Master COM1	10.0.50.100	UDP	5000	10.0.50.200~10.0.50.203	5000
				10.0.50.200~10.0.50.201	5001
SW5502 Slave 1 COM1	10.0.50.200	UDP	5000	10.0.50.100	5000
SW5502 Slave 1 COM2	10.0.50.200	UDP	5001	10.0.50.100	5001
SW5502 Slave 2 COM1	10.0.50.201	UDP	5000	10.0.50.100	5000
SW5502 Slave 2 COM2	10.0.50.201	UDP	5001	10.0.50.100	5001
SW5501 Slave 3 COM1	10.0.50.202	UDP	5000	10.0.50.100	5000
SW5501 Slave 4 COM1	10.0.50.203	UDP	5000	10.0.50.100	5000

### 5.2.9 TCP Server Application: Multiple TCP Connections

The multiple connection option will allow up to the maximum of four TCP Client connections. This can be enabled by changing the **Maximum Connection** option under the TCP Server section in TCP Server Link Mode settings.

Note that it is also possible to use this multiple connection feature in conjunction with other TCP Server applications, such as Virtual COM, Pair Connection, and Reverse Telnet. For example, enabling multiple connection option along with Pair Connection will result in Multi-Point Pair Connection in TCP Server Link Mode ([Paragraph 5.2.10 below](#)). For more information on response behavior option please go to [Paragraph 5.1.1 above](#).

#### LINK Mode

To choose specific working mode for COM 1 port.

TCP Server  TCP Client  UDP

TCP Server	
Application	RAW
IP Filter	<input type="checkbox"/> Enable
Source IP	0 . 0 . 0 . 0
Local Port	4660
Maximum Connection	4
Response Behavior	<input type="radio"/> Request & Response Mode <input type="radio"/> Reply to requester only <input type="radio"/> Reply to all <input checked="" type="radio"/> Transparent Mode

Figure 5.17 Setting of Multiple TCP Connection Application via Maximum Connection Option

### 5.2.10 TCP Server Application: Multi-Point TCP Pair Connections

The difference between Multi-Point TCP Pair Connection and Multi-Point UDP Pair Connection is that the TCP implementation would also exchange flow control pins for RS-232 as if COM interfaces of these devices are connected without SW550X. However, the TCP Server is limited to a maximum of four connections. If there are four serial devices and they don't use flow control pins with RS-232 or RS-485, it is possible to setup pair connection in UDP Link Mode as discussed in [Paragraph 5.2.8 above](#). After multiple connection option is enabled in the Web UI as described in previous sub-section, please refer to Table 5.2 for an example to setup Multi-Point TCP Pair Connections as depicted in the figure below. Please follow the steps for Pair Connection Master with TCP Server Link Mode settings and Pair Connection Slave with TCP Client Link Mode settings as described in [Paragraph 5.2.5 above](#) and [Paragraph 5.2.6](#), respectively.

Table 5.2 An Example of Multi-Point Pair Connection's Parameter Settings for TCP Link Mode

	IP Address	Link Mode	Application	Listening Port	Destination IP	Destination Port
SW5501 Master COM1	10.0.50.100	TCP Server	Pair Connection Master	4660	-	-
SW5502 Slave 1 COM1	10.0.50.200	TCP Client	Pair Connection Slave	-	10.0.50.100	4660
SW5502 Slave 1 COM2	10.0.50.200	TCP Client	Pair Connection Slave	-	10.0.50.100	4660
SW5501 Slave 2 COM1	10.0.50.201	TCP Client	Pair Connection Slave	-	10.0.50.100	4660
SW5501 Slave 3 COM1	10.0.50.202	TCP Client	Pair Connection Slave	-	10.0.50.100	4660

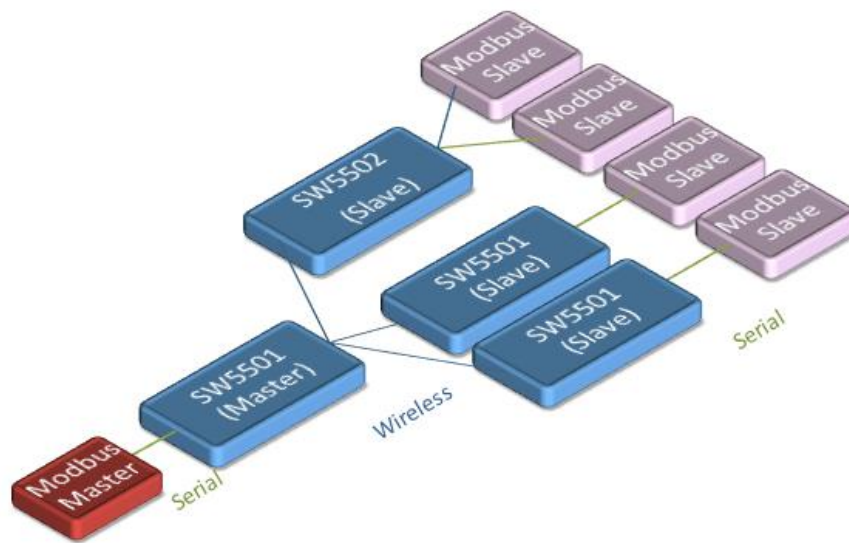

Figure 5.18 An Example of Network Topology for Multi-Point Pair Connection in TCP Link Mode

### 5.3 Wireless Topology

This section will describe example applications of wireless topologies and their corresponding wireless parameter settings for SW550X. Typically, IEEE 802.11 wireless network standards will support two wireless network topologies: ad-hoc and infrastructure modes.

In Ad Hoc mode, each wireless node will communicate directly with each other and have equal role in communication in which they are usually called peer.

On the other hand, in infrastructure mode, there will be one or more access points which will control the network and how other wireless nodes communicate with each other. Each wireless node will be called wireless client. In Infrastructure mode, each wireless node cannot communicate directly with each other. They must communicate via the access point only.

We can configure SW550X as a wireless ad-hoc peer or a wireless client in infrastructure mode. Note that SW550X cannot be operated as an access point in infrastructure mode. If you require an access point, please consider a deployment of Atop's AW5500 series. Atop recommends the user to utilize the strongest wireless security measure as described in the following subsections.

#### 5.3.1 Configure SW550X as a Wireless Ad-Hoc Peer

To configure SW550X as an ad-hoc peer, please click on **Basic Settings** page under the **Wireless** menu and follow steps in [Paragraph 4.2.1 above](#). Figure 5.19 shows an example of a wireless ad-hoc peer in IEEE 802.11b network with open authentication and no encryption. However, Atop recommends that you should enable the security mechanism using the Wire Equivalent Privacy (WEP) with 128-bit encryption key as summarized in Table 5.3.

Wireless > Basic Settings
SW5502

---

Basic Settings

SSID	Adhoc_Peer	<input type="button" value="scan network"/>
BSSID(MAC Address)	(Any)	<input type="checkbox"/> Enabled
WPS BUTTON	<input type="button" value="Start WPS PBC"/>	
Topology	Ad-Hoc ▾	
Band mode	802.11b ▾	<input type="checkbox"/> Auto
BandWidth	Auto 20/40 MHz ▾	
Channel	1 ▾	
Authentication Mode	OPEN ▾	
Encryption Type	NONE ▾	
<b>WEP Key</b>		
	<input checked="" type="radio"/> Key 1: ASCII (5 or 13 characters) ▾	<input type="text"/>
	<input type="radio"/> Key 2: HEX (10 or 26 digits) ▾	<input type="text"/>
	<input type="radio"/> Key 3: HEX (10 or 26 digits) ▾	<input type="text"/>
	<input type="radio"/> Key 4: HEX (10 or 26 digits) ▾	<input type="text"/>
<b>WPA-PSK/WPA2-PSK</b>		
Passphrase	••••••••	<input checked="" type="checkbox"/> Hide
<b>WPA2(with Radius)</b>		
User	wpa_user	
Password	••••••••	
Certificates	<input type="button" value="Browse..."/> No file selected.	
	<input type="button" value="Upload CA certificate"/> <input type="button" value="Upload Client certificate"/>	
	<input type="button" value="Show Certificates Information"/>	
Private key password	••••••••	

Figure 5.19 Wireless Ad-Hoc Peer Settings for SW550X

Table 5.3 Summary of Parameter Settings for Wireless Ad-Hoc Peer with WEP Security

<b>Topology</b>	<b>Adhoc</b>
Band Mode	802.11b (alternatively you could use 802.11a which is less affected by interference), it provides better wireless sensitivity with lower maximum rate at 11Mbps.
Tx Rate	Auto
Channel	1; we recommend using 1, 6, or 11 (for 2.4 GHz).
Authentication	Open
Encryption	WEP
WEP Key	For 64-bit encryption, enter 5 ASCII value or 10 Hexadecimal digits. For 128-bit encryption, enter 13 ASCII value or 26 Hexadecimal digits. Use 128-bit when possible.

### 5.3.2 *Configure SW550X as a Wireless Client in the Infrastructure mode (PSK)*

To configure SW550X as a Wireless Client in infrastructure mode with WPA2-PSK authentication mode and AES encryption, please click on **Basic Settings** page under the **Wireless** menu and follow steps in [Paragraph 4.2.1 above](#). The screenshot shows an example of a wireless client in infrastructure mode with these security mechanisms enabled as summarized in



Table 5.4.

Wireless > Basic Settings
SW5502

---

Basic Settings

SSID	AW5500	scan network
BSSID(MAC Address)	(Any)	<input type="checkbox"/> Enabled
WPS BUTTON	Start WPS PBC	
Topology	Infrastructure	
Band mode	802.11b/g	<input checked="" type="checkbox"/> Auto
BandWidth	Auto 20/40 MHz	
Channel	Auto	
Authentication Mode	WPA2-PSK	
Encryption Type	AES	
<b>WEP Key</b>		
	<input checked="" type="radio"/> Key 1: ASCII (5 or 13 characters)	<input type="text"/>
	<input type="radio"/> Key 2: HEX (10 or 26 digits)	<input type="text"/>
	<input type="radio"/> Key 3: HEX (10 or 26 digits)	<input type="text"/>
	<input type="radio"/> Key 4: HEX (10 or 26 digits)	<input type="text"/>
<b>WPA-PSK/WPA2-PSK</b>		
Passphrase	••••••••	<input checked="" type="checkbox"/> Hide
<b>WPA2(with Radius)</b>		
User	wpa_user	
Password	••••••••	
Certificates	Browse... No file selected.	
	<input type="button" value="Upload CA certificate"/> <input type="button" value="Upload Client certificate"/>	
	<input type="button" value="Show Certificates Information"/>	
Private key password	••••••••	

In Ad-Hoc mode, Device will change its settings to adapt to other, if there are same SSID nearby.

Figure 5.20 Wireless Client with WPA2-PSK Security Settings for SW550X

Table 5.4 Summary of Parameter Settings for Wireless Client in Infrastructure Topology with WPA2-PSK Security

<b>Topology</b>	Infrastructure
<b>Band Mode</b>	Auto
<b>Tx Rate</b>	Auto
<b>Channel</b>	Disabled (auto sensing)
<b>Authentication</b>	As defined by the Access Point
<b>Encryption</b>	As defined by the Access Point
<b>WPA2-PSK passphrase</b>	8~63 characters



**Attention**

We recommend using WPA2-PSK authentication with AES encryption as it is the most secure password-type security option without utilizing 802.1x.

**5.3.3 Click-2-Go**

It is possible to pair up two SW550X devices in Ad-Hoc mode or have them connect to AW5500 (Infrastructure) automatically without entering the Web UI. Please refer to Device Management’s manual for more details on this.

**5.3.4 Configure SW550X as a Wireless Client in the Infrastructure mode (PEAP-MSCHAPv2)**

To configure SW550X as a Wireless Client in infrastructure mode with PEAP-MSCHAPv2 authentication mode and AES encryption, please click on **Basic Settings** page under the **Wireless** menu and follow steps in [Paragraph 4.2.1 above](#). Figure below shows an example of a wireless client in infrastructure mode with this authentication mode enabled as summarized in Table 5.5.

The screenshot shows the 'Basic Settings' page for a wireless client on device SW5502. The settings are as follows:

- SSID:** AW5500 (with a 'scan network' button)
- BSSID(MAC Address):** (Any) (with an 'Enabled' checkbox)
- WPS BUTTON:** Start WPS PBC
- Topology:** Infrastructure (dropdown)
- Band mode:** 802.11b/g (dropdown) with 'Auto' checked
- BandWidth:** Auto 20/40 MHz (dropdown)
- Channel:** Auto (dropdown)
- Authentication Mode:** WPA/WPA2(PEAP) (dropdown)
- Encryption Type:** AES (dropdown)
- WEP Key:** Four keys are listed, with 'Key 1: ASCII (5 or 13 characters)' selected.
- WPA-PSK/WPA2-PSK:** Passphrase is masked with dots, and 'Hide' is checked.
- WPA2(with Radius):** User is 'wpa\_user' and Password is masked with dots.
- Certificates:** Includes a 'Browse...' button (No file selected), 'Upload CA certificate', 'Upload Client certificate', and 'Show Certificates Information' buttons.
- Private key password:** Masked with dots.

Figure 5.21 Wireless Client with PEAP Security Settings for SW550X

Table 5.5 Wireless Client-Infrastructure Topology Parameters with WPA2 (PEAP-MSCHAPv2) Security.

<b>Topology</b>	Infrastructure
<b>Band Mode</b>	Auto
<b>Tx Rate</b>	Auto
<b>Channel</b>	Disabled (auto sensing)
<b>Authentication</b>	WPA2 (PEAP)
<b>Encryption</b>	As defined by the Access Point
<b>Username</b>	Defined by the RADIUS Server
<b>Password</b>	Defined by the RADIUS Server

## 6 VCOM installation and troubleshooting

### 6.1 Enabling VCOM

SW550X will encapsulate control packets on top of the actual serial data when Virtual COM (VCOM) Application is enabled. This will allow the Virtual COM port in the Windows/Linux system to access SW550X's COM ports. Please note that Virtual COM Application can only be enabled in TCP Server Link Mode as shown in **Figure 6.1** or TCP Client Link Mode as shown in **Figure 6.2**.

**LINK Mode**

To choose specific working mode for COM 2 port.

TCP Server  TCP Client  UDP

TCP Server	
Application	RAW
IP Filter	<input type="checkbox"/> Enable
Source IP	0 . 0 . 0 . 0
Local Port	4660
Maximum Connection	1
Response Behavior	<input type="radio"/> Request & Response Mode <input type="radio"/> Reply to requester only <input checked="" type="radio"/> Reply to all <input checked="" type="radio"/> Transparent Mode

Figure 6.1 Enabled Virtual COM Application in TCP Server Link Mode

**LINK Mode**

To choose specific working mode for COM 2 port.

TCP Server  TCP Client  UDP

TCP Client	
Application	RAW
Destination IP 1	RAW
Destination Port 1	Virtual COM
Destination 2	<input type="checkbox"/> Enable
Destination IP 2	0 . 0 . 0 . 0
Destination Port 2	4661
Response Behavior	<input type="radio"/> Request & Response Mode <input type="radio"/> Reply to requester only <input checked="" type="radio"/> Reply to all <input checked="" type="radio"/> Transparent Mode

Figure 6.2 Enabled Virtual COM Application in TCP Client Link Mode

Virtual COM on host computer allows remote access of serial devices over TCP/IP networks through Serial/IP Virtual COM ports that work like local native COM ports. Figure 6.3 is an example of Virtual COM application diagram. In the diagram, multiple serial servers (i.e. SW550X devices) in which each one connects to serial device are connected over an Ethernet hub. Their serial devices can be accessed through the TCP/IP network of the hub. Note that there are only two Physical COM ports (COM 1 and COM 2) on the personal computer (PC) while there can be several Virtual COM ports such as COM 3, 4, 5, and so on. In SW550X case, the TCP/IP network can be either wired network such as Ethernet or wireless network such as Wi-Fi (IEEE 802.11).

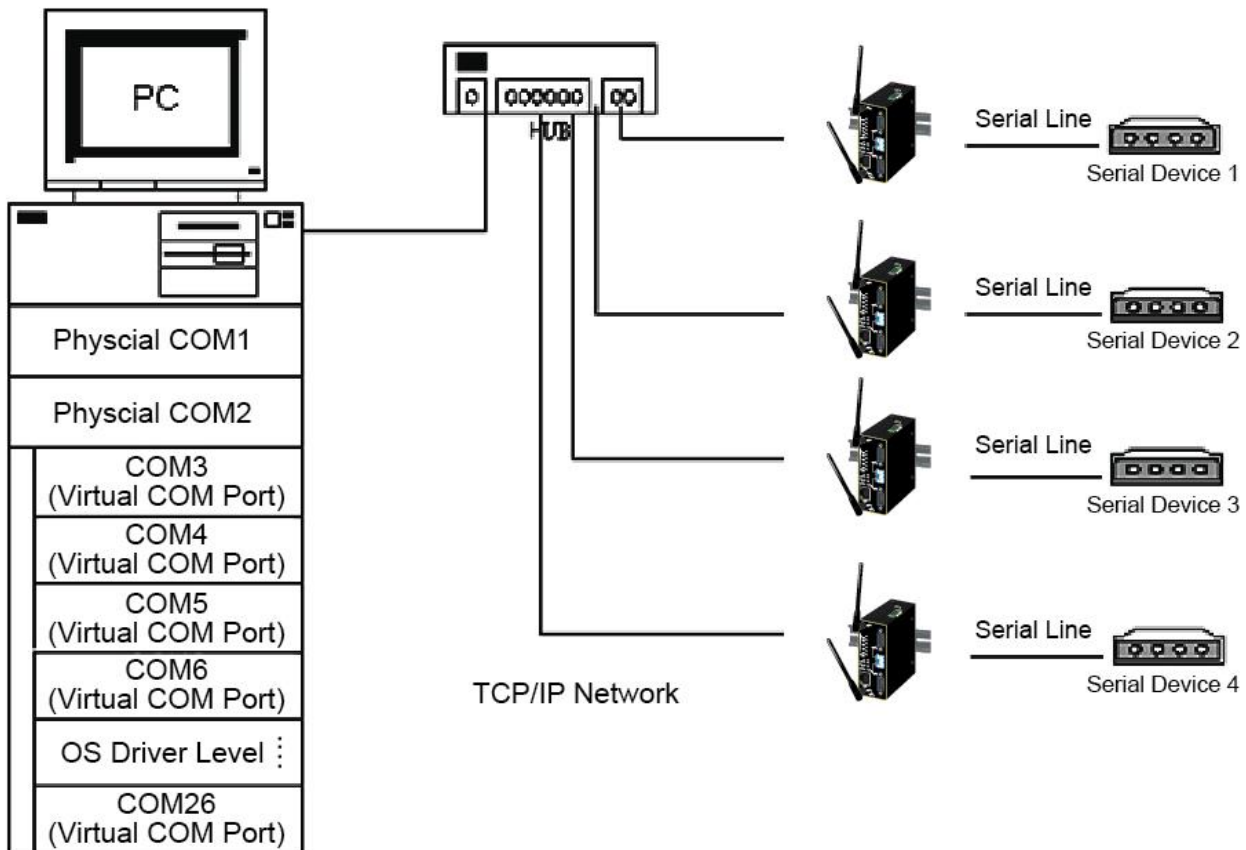

Figure 6.3 An Example Diagram of Virtual COM Application over TCP/IP Network

To enable Virtual COM on host computer, you will require a software utility or VCOM driver software to emulate the COM port. For Windows operating system, a software utility called Serial/IP is supported by Atop to be used for this purpose. Please see discussion about the VCOM driver utility in the following subsections.

### 6.1.1 VCOM Driver Setup

The supported VCOM driver or Serial/IP utility has the following requirements.

### System Requirements

- Windows Operating System Supported Platform (32/64 bits)
  - Win8
  - Win7
  - 2008

- Vista
  - XP
  - 2003 (also Microsoft 2003 Terminal Server)
  - 2000 (also Microsoft 2000 Terminal Server)
  - NT (also Microsoft NT Terminal Server)
  - 4.0
  - 9x
- Citrix MetaFrame Access Suite
  - **Linux** operating system, also available but first you might need to download a separate package called Virtual COM driver for Linux (**TTYredirector**) available for download on Atop Website or in the product CD. The zipped package includes a binary file for installation and a manual for Linux systems.

### 6.1.2 *Limitation*

The Virtual COM driver allows up to 256 **Virtual COM ports** in a single PC. Selection of COM port number can be allowed in the range from COM1 to COM4096. Note that COM ports that are already occupied by the system or other devices will not be available.

### 6.1.3 *Install*

Run the Virtual COM setup file included in the CD or download a copy from our website to install the Virtual COM driver for your operating system. Please turn off your anti-virus software and try again if the installation fails. At the end of the installation, please select at least one Virtual COM port from the Serial/IP Control Panel.

### 6.1.4 *Uninstall*

- 1) From Windows **Start** Menu select **Control Panel** then select **Add/Remove Programs**.
- 2) Select **Serial/IP Version x.x.x** in the list of installed software.
- 3) Click the **Remove** button to remove the program.

## 6.2 *Enable VCOM in Serial Device Servers and Select VCOM in Windows*

This section will provide the procedure to enable Virtual COM (VCOM) on SW550X and Windows based PC. Please follow the steps described here to configure your Virtual COM application.

### 6.2.1 *Enable VCOM in Serial Device Servers*

Enable Virtual COM in our serial device servers (i.e. SW550X) by logging into our Web UI. It is located under **COM 1** or **COM 2** configuration under **Serial** menu as described in [Section 4.5 above](#). Screenshot below shows how to enable Virtual COM in TCP Server Link Mode in SW550X. For a detail of **Link Mode configuration with Virtual COM**, please refer to the previous chapter starting from [Section 5.1 above](#) on **Link Mode** configurations.

#### LINK Mode

To choose specific working mode for COM 2 port.

TCP Server  TCP Client  UDP

TCP Server	
Application	Virtual COM ▾
IP Filter	<input type="checkbox"/> Enable
Source IP	0 . 0 . 0 . 0
Local Port	4660
Maximum Connection	1 ▾
Response Behavior	<input type="radio"/> Request & Response Mode <input type="radio"/> Reply to requester only <input checked="" type="radio"/> Reply to all <input checked="" type="radio"/> Transparent Mode

Figure 6.4 Enable Virtual COM Application for COM 2 in TCP Server Link Mode

### 6.2.2 *Running Serial/IP Software Utility in Windows*

After installation of Virtual COM driver on Windows operating system as described in [Paragraph 6.1.3 above](#), open Serial/IP Control Panel by following any one of these methods:

- 1) Click on Windows' **Start** menu □ Select **All Programs** □ Select **Serial/IP** □ Select **Control Panel**.
- 2) In the Windows' **Control Panel**, open the **Serial/IP** applet.
- 3) In the Windows notification area as shown in **Figure 6.5**, right click on the **Serial/IP** tray icon and click on **Configure...** menu to open the Serial/IP's Control Panel.

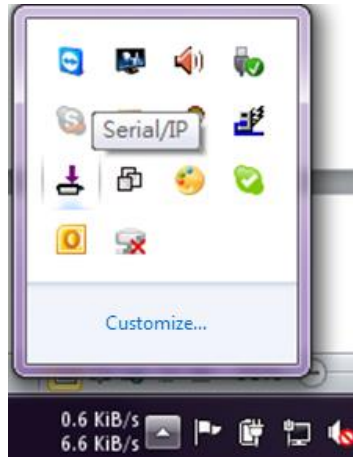

Figure 6.5 Serial/IP Tray Icon on Windows Notification Area

If no Virtual COM port is selected, a **"Select Ports"** dialog window will pop up and ask the user to select at least one COM port as the Virtual COM port before proceeding as shown in the pop-up window below. You can select a COM port by checking the box in front of the list of virtual COM ports. Note that if a COM port number is not on the list, it may be used by other application or your operating system. The user may want to select a range of multiple COM ports to be used as Virtual COM ports by entering the range of COM port in the text box below the list. After selecting the virtual COM ports, please click **OK** button to proceed.

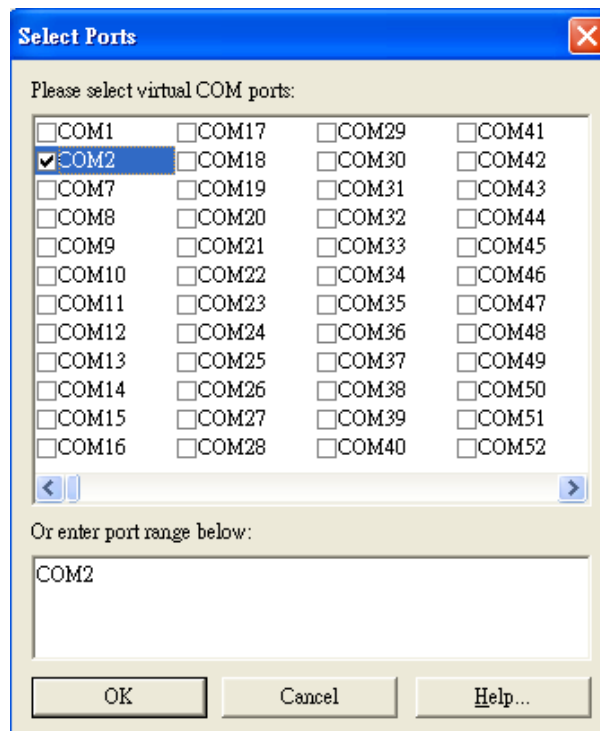

Figure 6.6 A Pop-up Window for Selecting Virtual COM Ports

After at least one Virtual COM port is selected, the **Serial/IP Control Panel** window will show up as illustrated in **Figure 6.7**. The left side of the Control Panel window shows the list of selected Virtual COM ports. You can click on **Select Ports...** button below the list to add or remove Virtual COM ports from the list. The right side of the **Serial/IP Control Panel** window shows the configurations of the selected Virtual COM port marked in blue on the list. Each



Virtual COM port can have its own settings. Details on how to configure the Virtual COM port will be described in the next subsection.

**Note:** The changes to Virtual COM ports apply immediately so there is no need to save the settings manually. However, if the Virtual COM port is already in use, it is necessary to close the Virtual COM port and open it after the TCP connection closes completely in order for the changes to take effect.

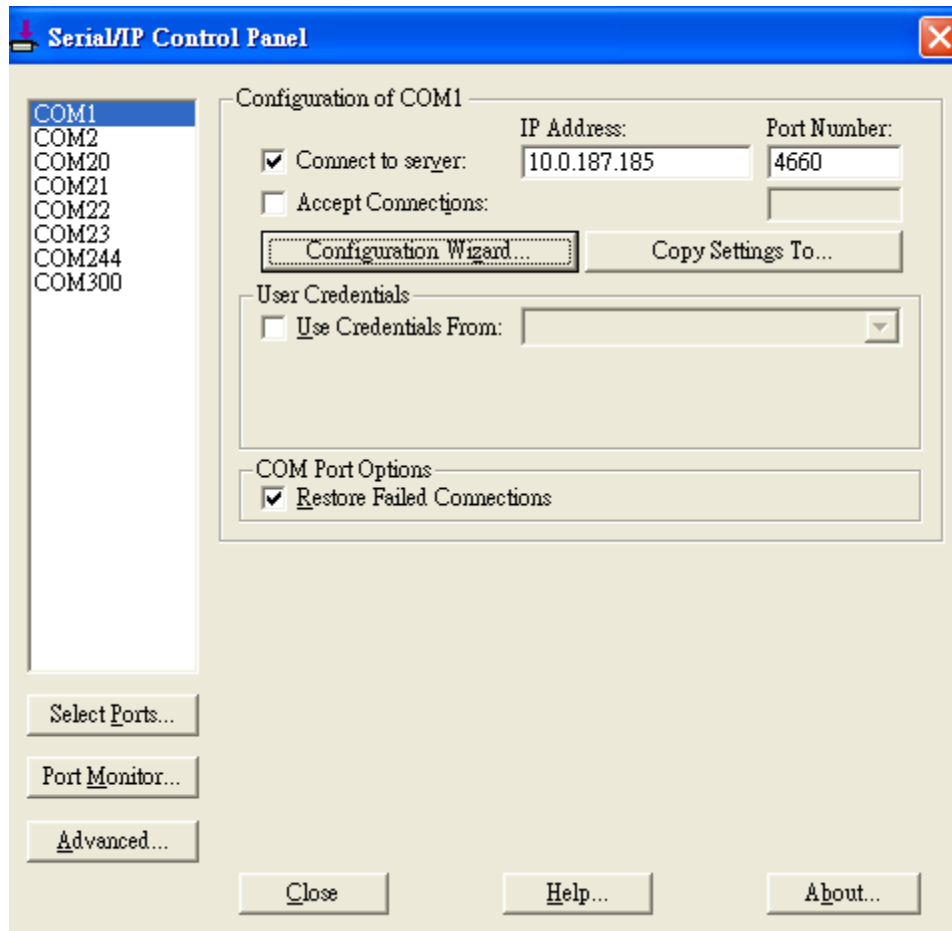

Figure 6.7 Serial/IP Control Panel Window

### 6.2.3 Configuring VCOM ports

For each VCOM port selected on the listed on the left-hand side of the Serial/IP Control Panel, you can use the following procedures to configure that VCOM port.

1. If the serial device server (i.e. SW550X) is running in TCP Server Link Mode (recommended), the Serial/IP utility on the host computer should be configured as the TCP Client connecting to the serial device server. Enable **Connect to Server** option (by checking the box in front of it as shown in Figure 6.8) and enter the **IP Address** of the serial device server with the specified **Port Number**. The **Port Number** here is the Local Listening Port for the serial device server which is specified in the **Local Port** field of Figure 6.4.
2. If the serial device server (i.e. SW550X) is running in TCP Client Link Mode, the Serial/IP utility on the host computer should be configured as the TCP Server waiting for a serial device server to connect to the host computer. Enable **Accept Connections** option (by checking the box in front of it) and enter the specified **Port Number**. This **Port Number** is the Destination Port of the serial device server. Do not enable **Connect to Server** option and **Accept Connections** option simultaneously.

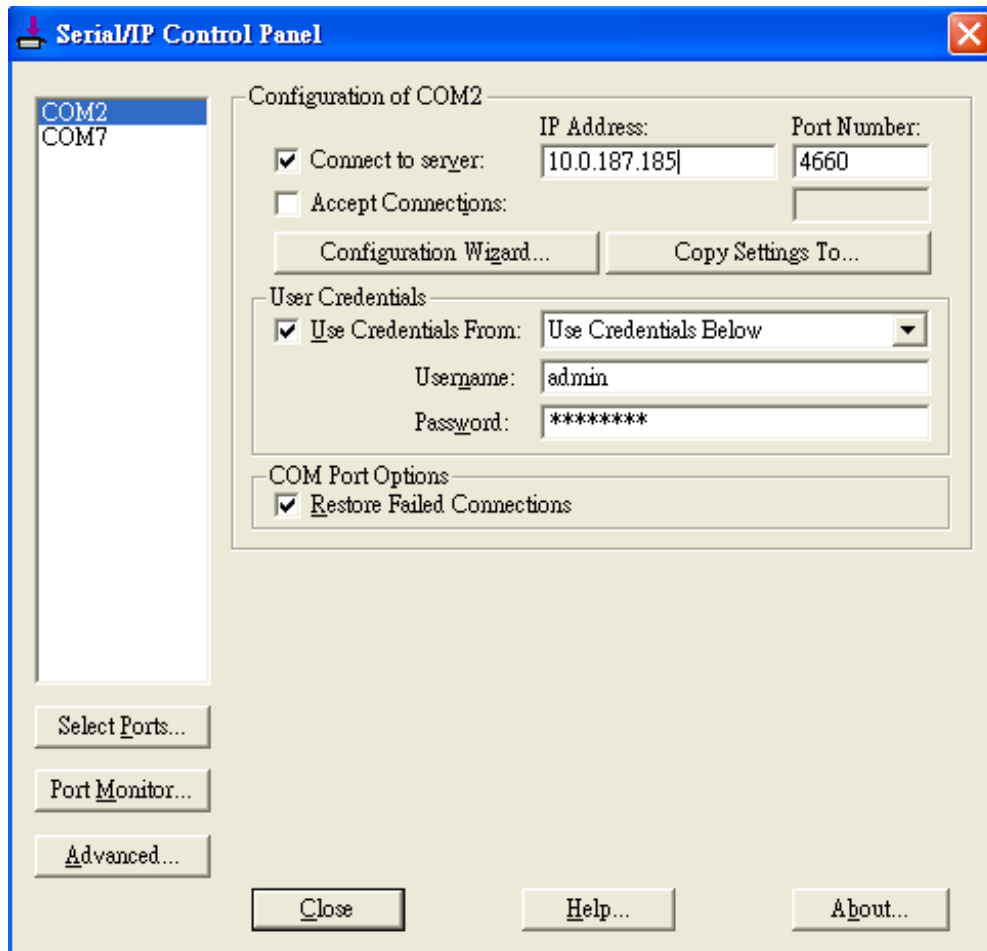

Figure 6.8 Configuring Virtual COM 2 Port as TCP Client

3. Under **User Credentials** box, you can enable **Use Credentials From:** option by checking the box in front of it then select options from the drop-down list. The available sources of credentials are: **Windows Credentials, Prompt on COM Port Open, Prompt at Login,** and **Use Credentials Below.** If you select **Use Credentials Below** option as shown in Figure 6.8, please specify the **Username** and the **Password** in their corresponding text boxes.
4. Under **COM Port Options** box, you can enable **Restore Failed Connections** option by checking the box in front of it to force Virtual COM to automatically restore failed connections with the serial device server in case of unstable network connections.
5. To test the Virtual COM connection, you can click the **Configuration Wizard...** button and then click the **Start** button in the pop up window as shown in Figure 6.9. If the test passes, all checks under the **Status** text box should be green. In this **Configuration Wizard** window, you can change the IP Address of Server, Port Number, Username (if **Use Credential** option is enabled), and Password (if **Use Credential** option is enabled). To apply the changes in the **Configuration Wizard** window to the Serial/IP Control Panel, please click on **Use Settings** button at the bottom of the window in Figure 6.9. You can also click on **Copy** button to copy the results to the PC system clipboard.
6. To transfer the settings between Virtual COM ports, click on the **Copy Settings To** button as shown in Figure 6.8.

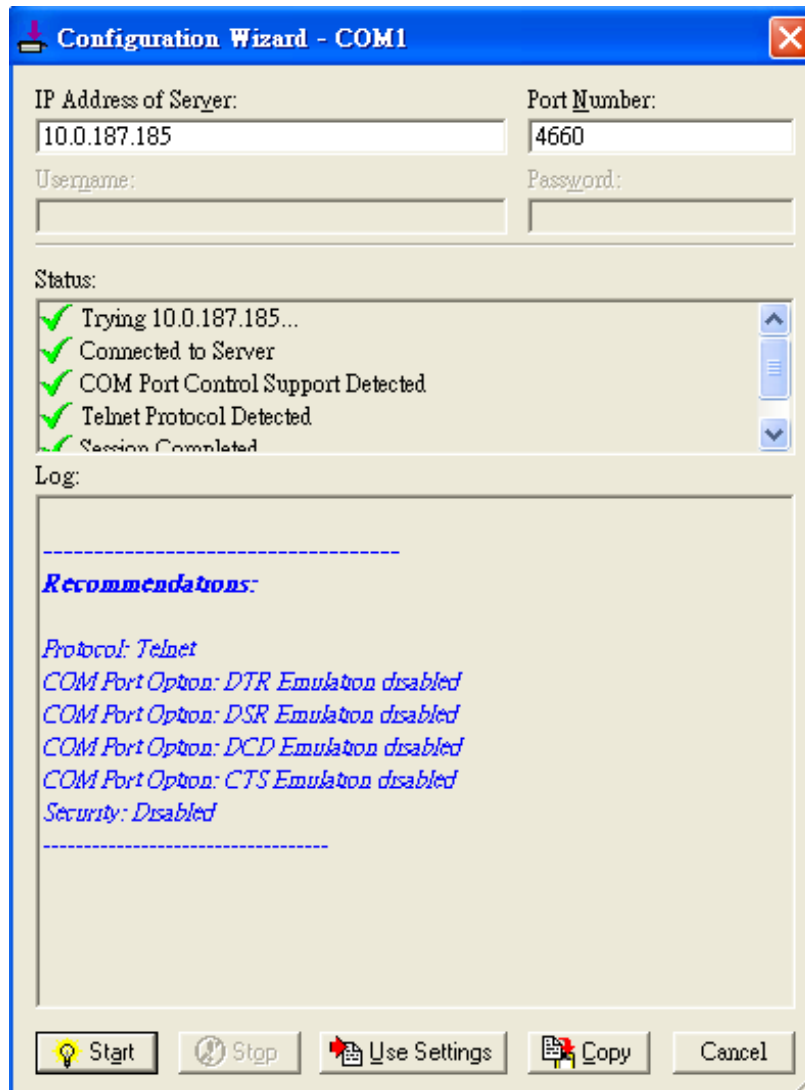

Figure 6.9 Configuration Wizard Window for COM 1

### 6.3 Exceptions

This section lists possible exceptions which may occur when the user tested the VCOM connection through the **Configuring Wizard...** button. If there is a problem with the connection, there will be error(s) or warning(s) reported in the **Status** and **Log** text boxes. The possible correction or trouble shooting hint for each exception is given in each case.

- If the status reports with an exclamation mark with a message “**Warning: timeout trying x.x.x.x**” as shown below, please recheck or correct the **VCOM IP address** and **Port number configuration** or the PC’s **network configuration**.

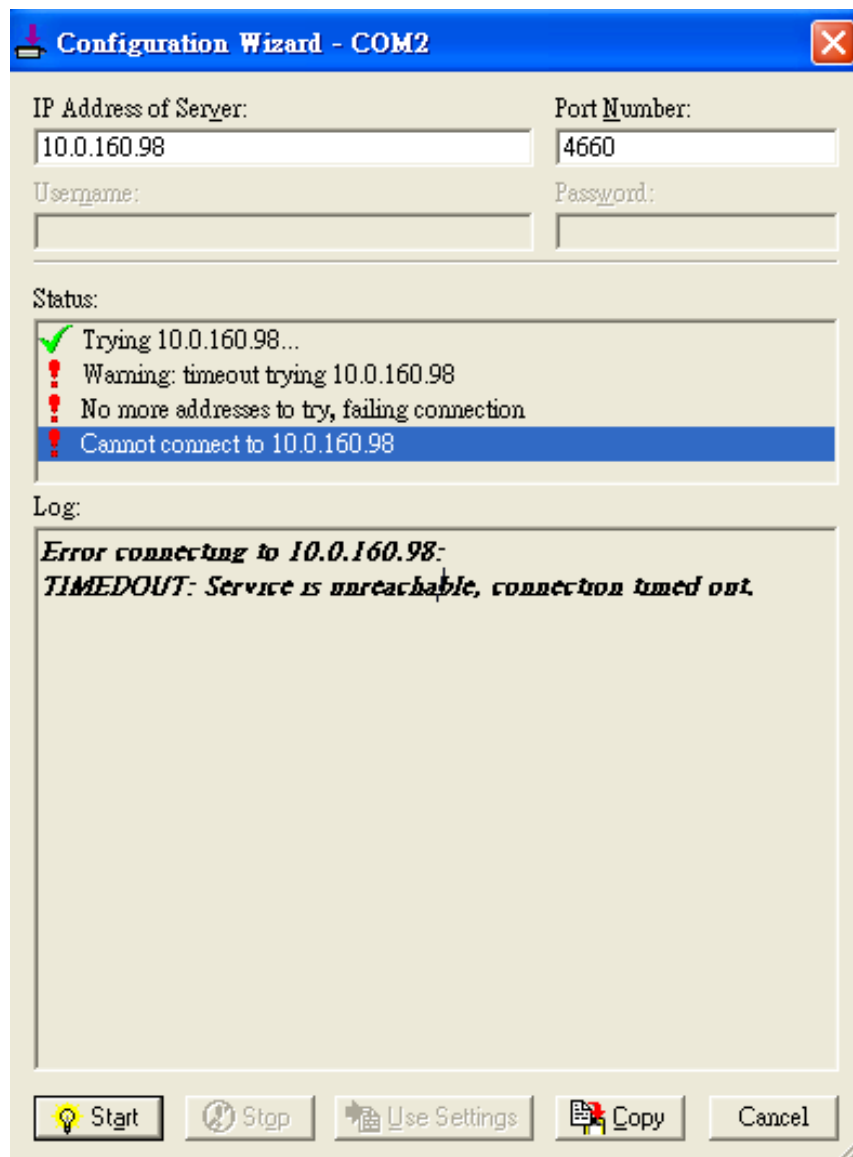

Figure 6.10 Timeout Warning on VCOM Connection

- If the status reports with a check with a message **“Raw TCP Connection Detected”** and an exclamation mark with a message **“Client not licensed for this server”** as shown in Figure 6.11. Please enable the **Virtual COM** option in the serial device server.

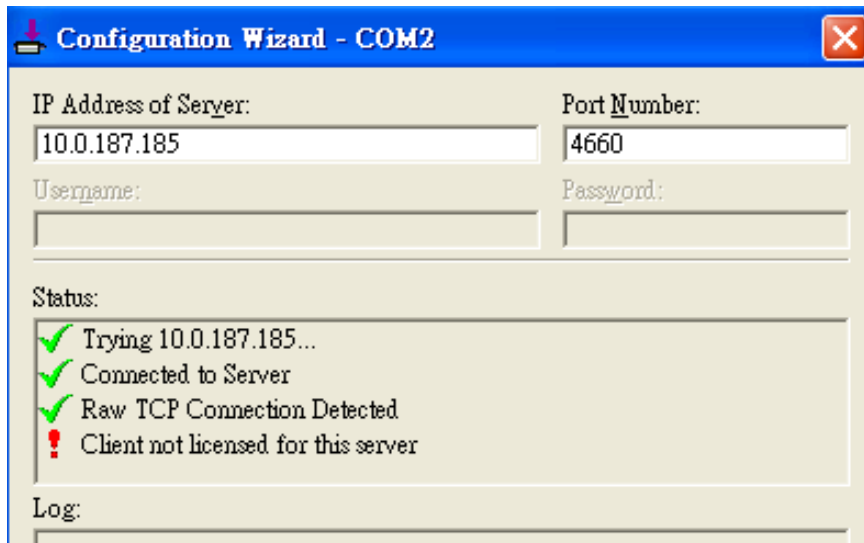

Figure 6.11 Error of Client not licensed for this server

- If the status reports with a check with a message **“Telnet Protocol Detected”** and an exclamation mark with a message **“Client not licensed for this server”** as shown in below. This means that there is a licensing issue between the serial device server (i.e. SW550X) and the Serial/IP Utility Software. Please contact Atop technical support to obtain the correct VCOM software.

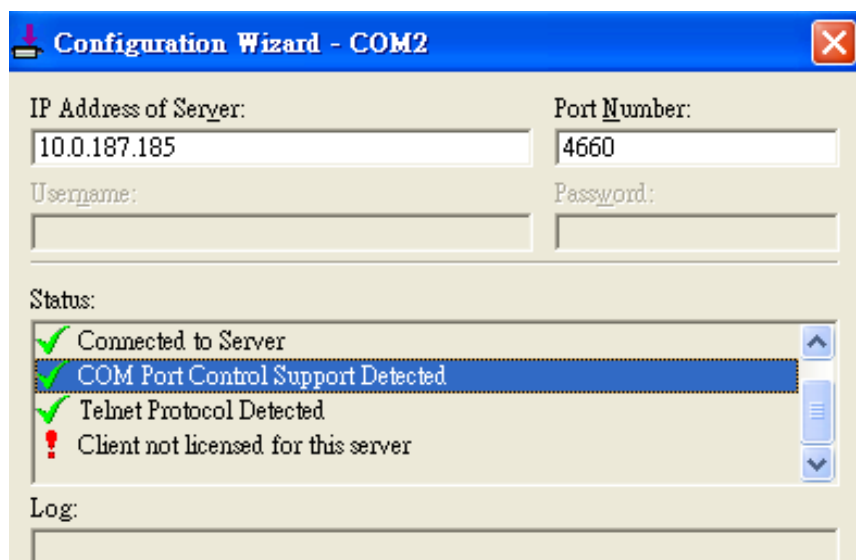

Figure 6.12 Licensing Issue of Serial/IP Utility Software

- If the status reports with an exclamation mark with a message **“Server requires username/password login”** as shown in Figure 5.13. This means that the **VCOM Authentication** option in the serial device server (i.e. SW550X) is enabled but the **User Credentials** option in the **Serial/IP** utility software is not enabled. Please follow the step in [Paragraph 6.2.3 above](#) for enabling the user credentials option and entering the username and the password.

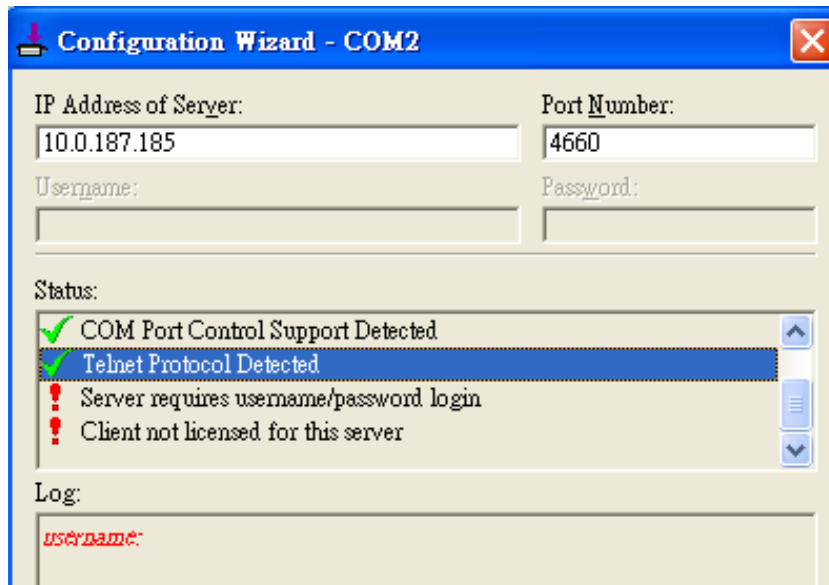

Figure 6.13 VCOM Authentication failed due to Missing Username/Password

- If the status reports with an exclamation mark with a message **“Username and/or password incorrect”** as shown in Figure 6.14. This means that the wrong username and/or password were entered and the authentication process failed.

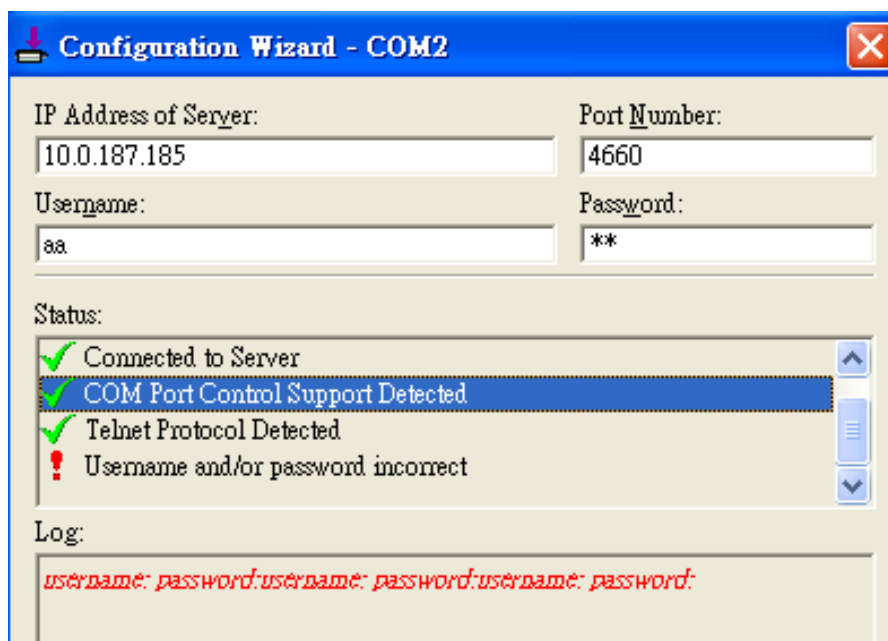

Figure 6.14 VCOM Authentication failed due to incorrect Username and/or Password

- If the status reports with an exclamation mark with a message **“No login/password prompts received from server”** as shown in Figure 6.15. This means that the User Credentials option in the **Serial/IP** utility software is enabled but the **VCOM Authentication** option in the serial device server (i.e. SW550X) is not enabled. Please enable the VCOM Authentication option on the SW550X by setting a new and non-blank administrator’s Username and Password for SW550X as described in [Paragraph 4.9.2 above](#). Note that the Username and the Password for VCOM authentication are the same username and password of SW550X Web UI login. The default account, which has the username as “admin” and no password or blank password, is considered as an unsecured account or no authentication option.

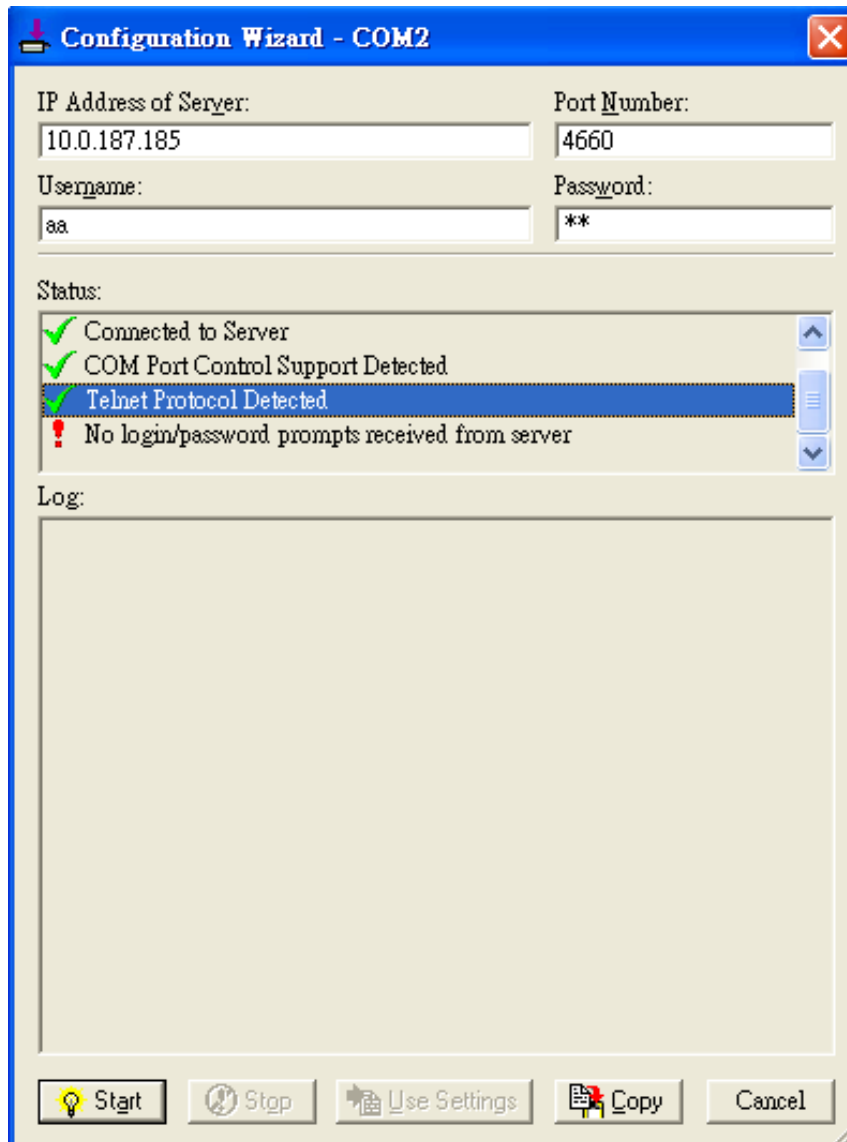

Figure 6.15 VCOM Authentication failed due to disabled VCOM Authentication on SW550X

## 6.4 Using Serial/IP Monitor

Serial/IP Port Monitor is another utility software provided for Atop's user. It allows user to monitor the activities or status of Virtual COM port and display the exchanged serial message which is called trace over the port.

### 6.4.1 Opening the Port Monitor

The Serial/IP Port Monitor utility can be opened by one of the following methods:

- Click on Windows's **Start** menu □ Select **All Programs** □ Select **Serial-IP** □ Select **Port Monitor**.
- Double click the Serial/IP tray icon in the Windows' notification area.
- In the Windows' notification area, right click on the Serial/IP tray icon and click on **Port Monitor** to open the Port Monitor.

Click on the **Port Monitor** button in the Serial/IP Control Panel's window.

### 6.4.2 Activity Panel

The **Activity** panel provides a real-time display of the status of all Serial/IP COM ports as shown below. If the Virtual COM Port is opened and is properly configured to connect to a serial device server (i.e. SW550X), the status would be **Connected**. If Serial/IP utility software cannot find the specified serial device server, the status would be **Offline**.

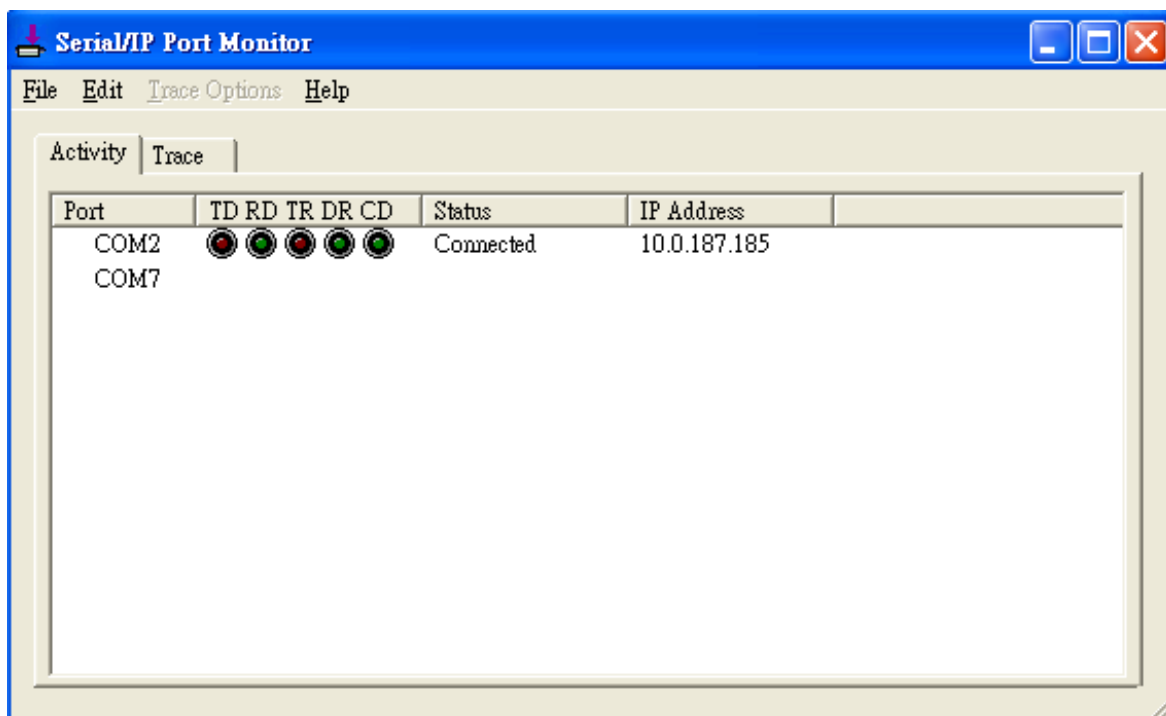

Figure 6.16 Activity Panel of Serial/IP Port Monitor

Each column in the Activity Panel is described as follows:

- **Port:** This is the virtual COM port number.
- **Line signal indicators:** Red color means no activity while green color indicates activity.
  - TD indicates data are being sent to the server.
  - RD indicates data are being received from the server.



- TR (DTR) is the signal from the application to the server that the application has opened the virtual COM port. The most common use of DTR is to programmatically lower it to signal a modem to disconnect.
- DR (DSR) is the signal from the server to the application that a modem or serial device is connected to the server and ready to communicate.
- CD (DCD) is the signal from the server to the application that a modem has successfully negotiated a connection with another device.
- **Status:** This indication the connection status of the software and serial device server which can be connected or offline.
- **IP Address:** This is the IP address of the serial device server.

**Notes:**

- The line signal indicators appear only when the virtual COM port is currently opened by an application.
- The TR, DR, and CD indicators appear only if the COM Port Control protocol is being used or if the COM port options are enabled.

**6.4.3 Trace Panel**

The **Trace** panel provides a detailed, time-stamped, real-time display of all Serial/IP COM ports operations. Click on **Enable Trace** box to start logging Virtual COM communication. To stop logging, uncheck the **Enable Trace** box. The user can toggle the format of the display between ASCII text (more readable) and hexadecimal format (most detailed) by checking the **Hex Display** box. Click on **Auto Scroll** box will cause the display to show the most recent trace data continuously. To ensure that Port Monitor’s window is always on top of other application’s windows, please check the **Always on Top** box. If you want to clear the displayed data in **Trace** panel, click on the **Clear** button.

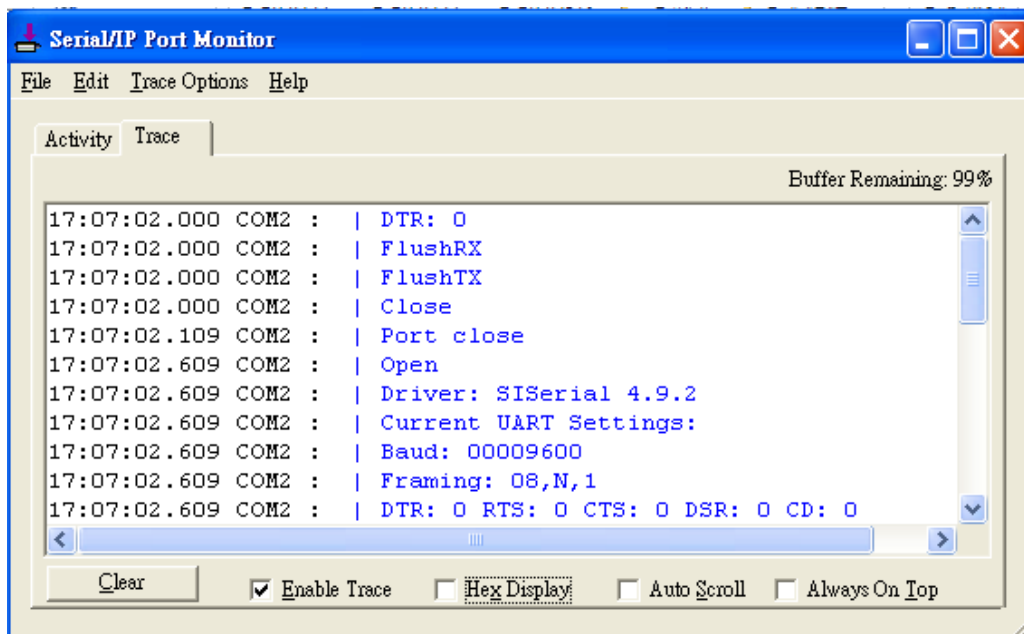

Figure 6.17 Trace Panel of Serial/IP Port Monitor

The pull-down menu of the Port Monitor windows allows the user to save the log and customize the capturing data of serial communication.

- **File:** To save the log file which you can send the log to Atop for further analysis if problems occurs with the Virtual COM connection, please click on **File** menu then click **Save As**.

- **Trace Options:**

- **Select Ports to Capture...:** This menu allows you to reduce the number of ports that are being traced to a subset of all configured Virtual COM ports. This feature can reduce the impact of tracing on memory and system performance for large applications.
- **Select Ports to Display...:** This menu allows you to reduce the number of ports that appear in the display to a subset of the ports being captured. For large applications, this feature provides a way to focus on ports of interest among all those being captured.
- **Buffer Size:** This menu allows the change on the amount of RAM being used for tracing which can be normal or large.
- **System Debug Output:** This menu allows user to enable the sending of trace data to the system debug channel and optionally put a label on them.

The **Trace** panel shows one serial event per line and in time order. Every event begins with a time tag. The transmit events will be shown in green and preceded by "»" while the receive event will be shown in red and preceded by "«". The control events will be shown in blue and preceded by "|".

**Notes:**

The Trace display covers up to 512k bytes of event data which is enough to cover a reasonably extensive tracing session. However, if the limit is reached, the trace clears and starts over.

## 6.5 Serial/IP Advanced Settings

In the Serial/IP Control Panel, you can click on the **Advanced...** button to open **Serial/IP Advanced Settings** window. The Serial/IP Advanced Settings window contains two tabs: Options and Proxy Server. On the Options tab, you can click on **Use Default Settings** button to load the default settings. Detail description of each options and how to set a proxy server will be explained in the following subsections.

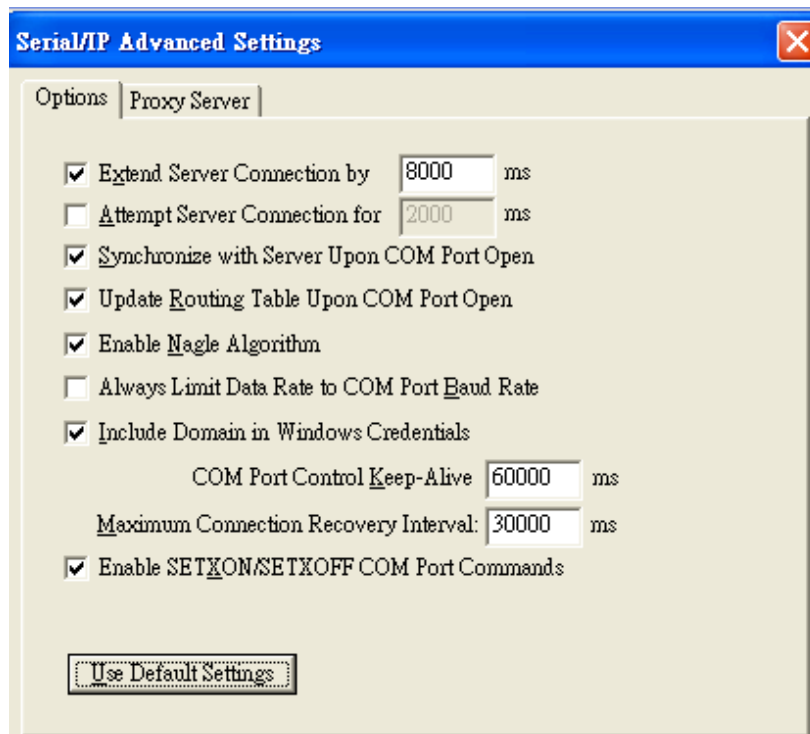

Figure 6.18 Serial/IP Advanced Settings Window

### 6.5.1 Advanced Settings Options

Under the Options tab, you can enable a number of advanced settings and enter required parameters for Serial/IP software. Description of each option is provided as follows.

- **Extend Server Connection:** When enabled, this option maintains the TCP connection for specified amount of time after COM port is closed. The default time value is 8000 milliseconds.
- **Attempt Server Connection:** When enabled, this option terminates pending connection attempts if they do not succeed in the specified time. The default time value is 2000 milliseconds.
- **Synchronize with Server Upon COM Port Open:** This option is required by Windows NT Operating Systems (also for Windows 2000, XP, Vista, 7).
- **Update Routing Table Upon COM Port Open:** When enabled, this option maintains IP route to a server in a different subnet by modifying the IP routing table.
- **Enable Nagle Algorithm:** When enabled, this option provides better network efficiency by imposing a minor latency on the data stream (TCP connection) while it waits to fill network packets.
- **Always Limit Data Rate to COM Port Baud Rate:** When enabled, this option limits the data rate to the baud rate that is in effect for the virtual COM port.

- **Include Domain in Windows Credentials:** If credential option is set to Windows Credentials (See option in [Paragraph 6.2.3 above](#)) and this option is enabled, VCOM automatically adds the current Windows domain to the username.
- **COM Port Control Keep-Alive:** This option controls the interval at which VCOM will issue the keep-alive message. If the value is set to zero, there will be no activity or no keep-alive packet sending out. The default value is 60000 milliseconds.
- **Maximum Connection Recovery Interval:** This option controls the maximum time for restoration of failed connection. The default value is 30000 milliseconds.

**Enable SETXON/SETXOFF COM Port Commands:** This option enables additional negotiation on SETXON and SETXOFF commands and is only available for the "V" series serial device servers. If the application requires SETXON/SETXOFF feature, please contact Atop Technical Support.

### 6.5.2 Using Serial/IP with a Proxy Server

The Serial/IP Redirector also supports TCP network connections made through a proxy server, which may be controlling access to external networks (such as the Internet) from a private network that lacks transparent IP-based routing, such as Network Address Translation (NAT). You can enable Serial/IP support of Virtual COM port through the proxy server using Serial/IP Proxy Server settings. You can find Proxy Server settings from the Advanced Settings windows and click on the **Proxy Server** tab as shown below. To enable the use of proxy server, check the box in front of **Use a Proxy Server** option. Then, select the **Protocol Type** which can be HTTPS or Socks V4 or Socks V5 from a drop-down list. Then, enter the IP address of the proxy server in the text box under **IP Address of Server** field and specify the **Port Number**. Note that the default port number for HTTPS is 8080, while for Socks V4 and V5 is 1080. Optionally, you can enter the Username and Password which may be required by your proxy server in the **Login to Server Using** box. Alternately, you can click on the Auto Detect button to have the software automatically detect the proxy server settings for you. Finally, you can test the proxy server settings by clicking on the **Test** button and stop the testing by clicking on **Stop** button.

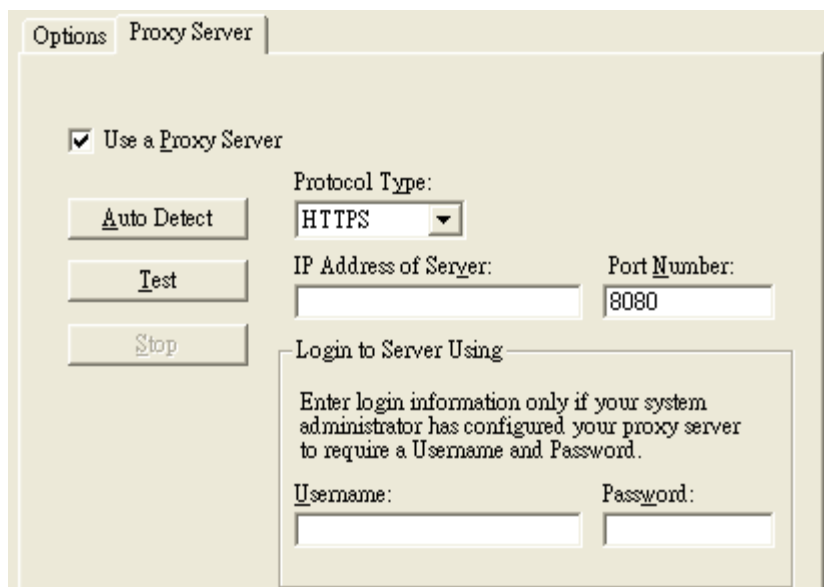

Figure 6.19 Proxy Server Tab under Serial/IP Advanced Settings

## 7 Specifications

### 7.1 Hardware Specifications

#### 7.1.1 Models of SW550X Series

Table 7.1 SW550X series and their interfaces

Name	Serial Port			Ethernet
	DB9	TB5	TB5(ISO)	RJ45
SW5501	1	--	--	1
SW5501-TB	--	1	--	1
SW5501-Sis	--	--	1	1
SW5502	1	--	--	1
SW5502-TB	--	1	--	1
SW5502-Sis	--	--	1	1

#### 7.1.2 Physical Characteristics

Table 7.2 Physical Characteristics of SW550X Series

Housing	Front-Panel	Weight	Dimensions	Installation
IP30 protection, SPCC case	Common ID design	500g (approx.)	47 mm x 110 mm x 90mm	<ul style="list-style-type: none"> <li>● DIN-Rail</li> <li>● Wall mount (optional kit)</li> </ul>

#### 7.1.3 LED Indicators

Table 7.3 Descriptions of LED Status Indicators

Name	Color	Status	Description
COM	Green	Blinking	Data is transmitting on the serial port
		Off	Data is not transmitting on the serial port
LAN	Orange	Blinking	Ethernet is connected on 10Mbps
		On	Ethernet is connected on 100/1000Mbps
		Off	Ethernet is disconnected
WLAN	Green	Blinking	Data is transmitting on Ethernet port
		On	Wireless radio is enabled
		Off	Wireless Radio is disabled (Mode LEDs should also disable)
RUN	Green	Off	System is not powered on
		Blinking Steadily	AP firmware is running normally
		Blinking Rapidly	AP firmware is not running

### 7.1.4 Signal LEDs

Symbols of LED's Status                      □ Off                      □ On                      □ blinking

Table 7.4 Interpretation of SW550X's Operation via Front Panel LEDs

Operations		Status	LED1	LED2	LED3	LED4	LED5
Connecting	Searching for an AP	□	□	□	□	□	□
	Cannot connected to the AP	□					
	No IP provided by the DHCP Server	□	□				
Connected	Signal Strength is less 20%	□					
	Bad Signal Strength (20%-40%)	□	□				
	Poor Signal Strength (40%-60%)	□	□	□			
	Fair Signal Strength (60%-80%)	□	□	□	□		
	Good Signal Strength (80%-94%)	□	□	□	□	□	
	Excellent Signal Strength (95%-100%)	□	□	□	□	□	□

### 7.1.5 Dip Switch (SW5501)

Table 7.5 Dip Switch Functions of SW5501

COM	Dip	Function	SW	Ω
COM1	3	Pull High	On	1K
			Off	100K
	2	Pull Low	On	1K
			Off	100K
	1	Termination	On	120
			Off	0

### 7.1.6 Dip Switch (SW5502)

Table 7.6 Dip Switch Function of SW5502

COM	Dip	Function	SW	Ω
COM1	6	Pull High	On	1K
			Off	100K
	5	Pull Low	On	1K
			Off	100K
	4	Termination	On	120
			Off	0
COM2	3	Pull High	On	1K
			Off	100K
	2	Pull Low	On	1K
			Off	100K
	1	Termination	On	120
			Off	0

**7.1.7 Wireless Specifications**

Table 7.7 Wireless Interface Specification of SW550X Series

PCI-e Module	Tx/Rx	Wireless Standard Conformance	Antenna
Atheros AR9382	2T2R MIMO (2x2 with MCS 0-15)	<ul style="list-style-type: none"> <li>■ 802.11a</li> <li>■ 802.11b</li> <li>■ 802.11g</li> <li>■ 802.11n</li> </ul>	<ul style="list-style-type: none"> <li>■ 3/5 dBi Dual antenna design</li> <li>■ SMA(R) Female connector</li> </ul>

**7.1.8 Frequency Range:**

Table 7.8 Operating Frequencies in Different Regions at 2.4GHz and 5GHz

	2.4Ghz	5Ghz
United States (FCC)	<ul style="list-style-type: none"> <li>■ 2412-2462(20Mhz)</li> <li>■ 2422-2452(40Mhz)</li> </ul>	<ul style="list-style-type: none"> <li>■ 5180-5240, 5745-5825(20Mhz)</li> <li>■ 5190-5230, 5755-5795(40Mhz)</li> </ul>
Europe (ETSI)	<ul style="list-style-type: none"> <li>■ 2412-2472(20Mhz)</li> <li>■ 2422-2462(40Mhz)</li> </ul>	<ul style="list-style-type: none"> <li>■ 5180-5240(20Mhz)</li> <li>■ 5190-5230(40Mhz)</li> </ul>
Taiwan (NCC)	<ul style="list-style-type: none"> <li>■ 2412-2462(20Mhz)</li> <li>■ 2422-2452(40Mhz)</li> </ul>	<ul style="list-style-type: none"> <li>■ 5280-5320, 5745-5825(20Mhz)</li> <li>■ 5310, 5755-5795(40Mhz)</li> </ul>

**7.1.9 Data Rate:**

Table 7.9 Supported Data Rate for Wireless Interface under IEEE 802.11 Standards

<b>802.11a</b>	6, 9, 12, 18, 24, 36, 48, 54Mbps	
<b>802.11b</b>	1, 2, 5.5 and 11Mbps	
<b>802.11g</b>	6, 9, 12, 18, 24, 36, 48, 54Mbps	
<b>802.11n</b>	20 MHz	<ul style="list-style-type: none"> <li>■ 1Nss: 65Mbps @ 800GI, 72.2Mbps @ 400GI (Max.)</li> <li>■ 2Nss: 130Mbps @ 800GI, 144.4Mbps @ 400GI (Max.)</li> </ul>
	40MHz	<ul style="list-style-type: none"> <li>■ 1Nss: 135Mbps @ 800GI, 150Mbps @ 400GI (Max.)</li> <li>■ 2Nss: 270Mbps @ 800GI, 300Mbps @ 400GI (Max.)</li> </ul>

**7.1.10 Output Power**

Table 7.10 Maximum Output Power of Wireless Interface under IEEE 802.11 Standards

802.11a	<ul style="list-style-type: none"> <li>■ +15dBm @ 6, 9, 12, 18, 24Mbps</li> <li>■ +15dBm @ 36Mbps</li> <li>■ +12dBm @ 54Mbps</li> </ul>	<ul style="list-style-type: none"> <li>■ +14dBm @ 48Mbps</li> <li>■ +12dBm @ 54Mbps</li> </ul>
802.11b	<ul style="list-style-type: none"> <li>■ +14dBm</li> </ul>	
802.11g	<ul style="list-style-type: none"> <li>■ +17dBm @ 6, 9, 12,18,24Mbps</li> <li>■ +17dBm @ 36Mbps</li> </ul>	<ul style="list-style-type: none"> <li>■ +16dBm @ 48Mbps</li> <li>■ +16dBm @ 54Mbps</li> </ul>
802.11n 2.4GHz/HT20	<ul style="list-style-type: none"> <li>■ +16dBm @ MCS 0/8</li> <li>■ +16dBm @ MCS 1/9</li> <li>■ +16dBm @ MCS 2/10</li> <li>■ +16dBm @ MCS 3/11</li> </ul>	<ul style="list-style-type: none"> <li>■ +16dBm @ MCS 4/12</li> <li>■ +16dBm @ MCS 5/13</li> <li>■ +16dBm @ MCS 6/14</li> <li>■ +15dBm @ MCS 7/15</li> </ul>
802.11n 2.4GHz/HT40	<ul style="list-style-type: none"> <li>■ +15dBm @ MCS 0/8</li> <li>■ +15dBm @ MCS 1/9</li> <li>■ +15dBm @ MCS 2/10</li> <li>■ +15dBm @ MCS 3/11</li> </ul>	<ul style="list-style-type: none"> <li>■ +15dBm @ MCS 4/12</li> <li>■ +15dBm @ MCS 5/13</li> <li>■ +15dBm @ MCS 6/14</li> <li>■ +14dBm @ MCS 7/15</li> </ul>
802.11n 5GHz/HT20	<ul style="list-style-type: none"> <li>■ +15dBm @ MCS 0/8</li> <li>■ +15dBm @ MCS 1/9</li> <li>■ +15dBm @ MCS 2/10</li> <li>■ +15dBm @ MCS 3/11</li> </ul>	<ul style="list-style-type: none"> <li>■ +15dBm @ MCS 4/12</li> <li>■ +11 - 14dBm @ MCS 5/13</li> <li>■ +9 - 12dBm @ MCS 6/14</li> <li>■ +7 - 10dBm @ MCS 7/15</li> </ul>
802.11n 5GHz/HT40	<ul style="list-style-type: none"> <li>■ +14dBm @ MCS 0/8</li> <li>■ +14dBm @ MCS 1/9</li> <li>■ +14dBm @ MCS 2/10</li> <li>■ +14dBm @ MCS 3/11</li> </ul>	<ul style="list-style-type: none"> <li>■ +14dBm @ MCS 4/12</li> <li>■ +10- 13dBm @ MCS 5/13</li> <li>■ +8 - 11dBm @ MCS 6/14</li> <li>■ +6 - 9dBm @ MCS 7/15</li> </ul>

**7.1.11 Receiver Sensitivity**

Table 7.11 Receiver Sensitivity of Wireless Interface under IEEE 802.11 Standards

Standard	Data Rate	IEEE Spec (1 Rx dBm)	Typical/Maximum (2Rx dBm)
802.11a	6M	-82	-95/-85
	9M	-81	-94/-84
	12M	-79	-93/82
	18M	-77	-90/-80
	24M	-74	-88/-77
	36M	-70	-84/-73
	48M	-66	-82/-69
	54M	-65	-81/-68
802.11b	1M	not specified	-98/-85
	5.5M	not specified	-98/-85
	11M	not specified	-94/-85
802.11g	6M	-82	-96/-85
	9M	-81	-96/-84



Standard	Data Rate	IEEE Spec (1 Rx dBm)	Typical/Maximum (2Rx dBm)
	12M	-79	-95/-82
	18M	-77	-93/-80
	24M	-74	-90/-77
	36M	-70	-87/-73
	48M	-66	-83/-69
	54M	-65	-82/-68
802.11a/n HT20	MCS0	-82	-94/-85
	MCS1	-79	-92/-82
	MCS2	-77	-90/-80
	MCS3	-74	-87/-77
	MCS4	-70	-84/-73
	MCS5	-66	-79/-69
	MCS6	-65	-78/-68
802.11a/n HT40	MCS0	-79	-92/-82
	MCS1	-76	-90/-79
	MCS2	-74	-87/-77
	MCS3	-71	-84/-74
	MCS4	-67	-80/-70
	MCS5	-63	-76/-66
	MCS6	-62	-74/-65
802.11b/g/n HT20	MCS0	-82	-95/-85
	MCS1	-79	-94/-82
	MCS2	-77	-92/-80
	MCS3	-74	-89/-77
	MCS4	-70	-86/-73
	MCS5	-66	-82/-69
	MCS6	-65	-80/-68
802.11b/g/n HT40	MCS0	-79	-92/-82
	MCS1	-76	-92/-79
	MCS2	-74	-89/-77
	MCS3	-71	-86/-74
	MCS4	-67	-83/-70
	MCS5	-63	-77/-66
	MCS6	-62	-76/-65
MCS7	-61	-75/-64	

### 7.1.12 Security

Supported Wireless Security Mechanisms

- 64-bit and 128-bit WEP encryption
- 802.1x authentication
- AES and TKIP, WPA/WPA2

### 7.1.13 Regulatory Requirements

Table 7.12 Conformed Radio Frequency and Electromagnetic Standards

<b>EMC</b>	<ul style="list-style-type: none"> <li>▪ EN 301 489-1 V1.9.2 (2011-09)</li> <li>▪ EN 301 489-17 V2.2.1 (2012-09)</li> </ul>
<b>Radio</b>	<ul style="list-style-type: none"> <li>▪ 47 CFR FCC Part 15 Subpart C § 15.247</li> <li>▪ 47 CFR FCC Part 15 Subpart E § 15.407</li> <li>▪ EN 300 328 V1.8.1 (2012-06)</li> <li>▪ EN 301 893 V1.7.1 (2012-06)</li> </ul>
<b>EMF</b>	<ul style="list-style-type: none"> <li>▪ 47 CFR FCC Part 2 Subpart J, section 2.1091</li> <li>▪ EN 62311:2008 and EN 50385:2002</li> </ul>

Table 7.13 Conformed Electrical Standards

Test	Item	Value	Level	
IEC61000-4-2	ESD	Contact Discharge	±8KV	4
		Air Discharge	±15KV	4
IEC61000-4-3	RS	Radiated(Enclosure)	10(V/m)	3
IEC61000-4-4	EFT	AC Power Port	±2.0 KV	3
		LAN Port	±2.0 KV	4
		COM Port	±2.0 KV	4
IEC61000-4-5	Surge	AC Power Port	Line-to-Line±1.0 KV	3
		AC Power Port	Line-to-Earth±2.0 KV	3
		LAN Port	Line-to-Earth±2.0 KV	3
		COM Port	Line-to-Earth±2.0 KV	3
IEC61000-4-6	CS	Conducted(Enclosure)	10 V rms	3
IEC61000-4-8	PFMF	(Enclosure)	10(A/m)	3
IEC61000-4-11	DIP	AC Power Port	-	-

\*AC Ports are tested through an authorized power adaptor.

**7.1.14 Environmental Limits**

- **Operating Temperature:** -10°C ~60°C (-4°F ~149°F)
- **Storage Temperature:** -40°C ~85°C (-40°F ~ 185°F)
- **Ambient Relative Humidity:** 5~95%RH, (non-condensing)

**7.1.15 Other**

- Safety: UL60950-1/CB, EN60950-1, CNS 14336
- Shock: IEC 60068-2-27
- Freefall: IEC 60068-2-32
- Vibration: IEC 60068-2-6
- MTBF: 20 years (TBD)
- RoHS: Yes
- Maritime: N/A

**7.2 Software Specifications**

Table 7.14 Software Specifications

<b>Configuration</b>	<ul style="list-style-type: none"> <li>■ Browser (IE8+, Firefox 6+, and Chrome 13+)</li> <li>■ Telnet</li> <li>■ Device Management© (Atop's Windows utility)</li> </ul>
<b>Protocol</b>	<ul style="list-style-type: none"> <li style="width: 33%;">■ ICMP</li> <li style="width: 33%;">■ DNS</li> <li style="width: 33%;">■ HTTP</li> <li style="width: 33%;">■ TCP</li> <li style="width: 33%;">■ SNMP</li> <li style="width: 33%;">■ Telnet</li> <li style="width: 33%;">■ RADIUS</li> <li style="width: 33%;">■ UDP</li> <li style="width: 33%;">■ NTP</li> <li style="width: 33%;">■ IPv4</li> <li style="width: 33%;">■ Syslog</li> <li style="width: 33%;">■ DHCP</li> <li style="width: 33%;">■ SMTP</li> <li style="width: 33%;">■ 802.1x</li> </ul>
<b>Alert Events</b>	<ul style="list-style-type: none"> <li>■ E-mail</li> <li>■ SNMP Trap</li> </ul>
<b>Radio OFF option</b>	Yes
<b>Other</b>	<ul style="list-style-type: none"> <li>■ Import / Export Configuration from Web with Wireless settings</li> <li>■ Firmware upgrade through Web or <b>Device Management©</b></li> <li>■ Site Monitor / Site Survey</li> <li>■ LAN / WLAN Bridge (AP Client)</li> <li>■ Management List</li> </ul>

## 8 Emergency System Recovery

If the device becomes inaccessible and the management utility cannot find the device, please use the following procedure to recover the devices over Trivial File Transfer Protocol (TFTP).

### System Recovery Procedures

System recovery is based on the TFTP Client embedded in the device. It can recover the device from a bad firmware or other unknown reasons corrupting the firmware image inside the flash memory. Please follow the procedures below to force SW550X to download a valid firmware from the TFTP Server to recover its operating system.

Default Settings	
TFTP Server	10.0.50.201
TFTP Server Subnet Mask	255.255.0.0
Name of firmware Image*	firmware.dld
*This firmware image can be obtained from Atop's website.	

- If the device is beeping continuously after power up, this means that the bootloader is damaged and there is no way to recover it. Please contact Atop directly to obtain RMA number for further solutions.
- Obtain and setup a **TFTP server** on your **PC**. Make sure that the **PC's network settings** are set properly according to the default setting in the above table.
- Rename the firmware image that you obtained from our website to "firmware.dld" and place it in the TFTP Server's root directory. For Solarwinds TFTP Server, it is usually **C:\TFTP-Root**.
- Make sure that the device is powered OFF and the Ethernet cable is plugged in.
- Press and hold the "reset-to-default" pin next to the Antenna 2 then power ON the device. If the bootloader is still functioning, the user will hear one long beep followed by two shorter beeps.
- Release the reset pin after hearing seven consecutive short beeps. Then, the device will automatically request files from TFTP Server. Please wait until the device shows up on the management utility. This process could take up to five minutes or even more.

### Important Note

Free TFTP Servers can be downloaded from the following locations:

<b>Solarwinds TFTP Server</b>	<a href="http://www.solarwinds.com/products/freetools/free_tftp_server.aspx">http://www.solarwinds.com/products/freetools/free_tftp_server.aspx</a>
<b>Note:</b> for Solarwinds, please remember to Start the TFTP Server Service, the default state of the TFTP is Stop.	
TFTPD32 TFTP Server	<a href="http://tftpd32.jounin.net/tftpd32.html">http://tftpd32.jounin.net/tftpd32.html</a>

## 9 Warranty

### Limited Warranty Conditions

Products supplied by Atop Technologies Inc. are covered in this warranty for undesired performance or defects resulting from shipping, or any other event deemed to be the result of Atop Technologies Inc.'s mishandling. The warranty does not cover; however, equipment which has been damaged due to accident, misuse, abuse, such as:

- Use of incorrect power supply, connectors, or maintenance procedures
- Use of accessories not sanctioned by us
- Improper or insufficient ventilation
- Improper or unauthorized repair
- Replacement with unauthorized parts
- Failure to follow our operating Instructions
- Fire, flood, "Act of God", or any other contingencies beyond our control.

### RMA and Shipping Reimbursement

- Customers must always obtain an authorized "**RMA**" number from us before shipping the goods to be repaired.
- When in normal use, a sold product shall be replaced with a new one within 3 months upon purchase. The shipping cost from the customer to us will be reimbursed.
- After 3 months and still within the warranty period, it is up to us whether to replace the unit with a new one; normally, as long as a product is under warranty, all parts and labor are free-of-charge to the customers.
- After the warranty period, the customer shall cover the cost for parts and labor.
- Three months after purchase, the shipping cost from you to us will not be reimbursed, but the shipping costs from us to the customer will be paid by us.

### Limited Liability

Atop Technologies Inc. shall not be held responsible for any consequential losses from using our products.

### Warranty

Atop Technologies Inc., gives a 5-year maximum warranty for Industrial Wireless Serial Device Server products.



*Atop Technologies, Inc.*

www.atoponline.com  
www.atop.com.tw

**TAIWAN HEADQUARTER:**

2F, No. 146, Sec. 1, Tung-Hsing Rd,  
30261 Chupei City, Hsinchu County  
Taiwan, R.O.C.  
Tel: +886-3-550-8137  
Fax: +886-3-550-8131

**ATOP CHINA BRANCH:**

3F, 75<sup>th</sup>, No. 1066 Building,  
Qingzhou North Road,  
Shanghai, China  
Tel: +86-21-64956231

**ATOP INDIA OFFICE:**

Abhishek Srivastava  
Head of India Sales  
Atop Communication Solution(P) Ltd.  
No. 22, Kensington Terrace,  
Kensington Rd,  
Bangalore, 560008, India  
Tel: +91-80-4920-6363  
E-mail: Abhishek.S@atop.in

**ATOP INDONESIA BRANCH:**

Jopson Li  
Branch Director  
Wisma Lampung Jl.  
No. 40, Tomang Raya  
Jakarta, Barat, 11430, Indonesia  
Tel: +62-857-10595775  
E-mail: jopsonli@atop.com.tw

**ATOP EMEA OFFICE:**

Bhaskar Kailas (BK)  
Vice President (Business Development)  
Atop Communication Solution(P) Ltd.  
No. 22, Kensington Terrace,  
Kensington Rd,  
Bangalore, 560008, India  
Tel: +91-988-0788-559  
E-mail: Bhaskar.k@atop.in

**ATOP AMERICAs OFFICE:**

Venke Char  
Sr. Vice President & Head of Business  
11811 North Tatum Blvd, Suite 3031  
Phoenix, AZ 85028,  
United States  
Tel: +1-602-953-7669  
E-mail: venke@atop.in